

ETSI TS 102 223 V4.6.0 (2003-09)

Technical Specification

Smart cards; Card Application Toolkit (CAT) (Release 4)



Reference

RTS/SCP-03002r10

Keywords

smart card

ETSI

650 Route des Lucioles
F-06921 Sophia Antipolis Cedex - FRANCE

Tel.: +33 4 92 94 42 00 Fax: +33 4 93 65 47 16

Siret N° 348 623 562 00017 - NAF 742 C
Association à but non lucratif enregistrée à la
Sous-Préfecture de Grasse (06) N° 7803/88

Important notice

Individual copies of the present document can be downloaded from:

<http://www.etsi.org>

The present document may be made available in more than one electronic version or in print. In any case of existing or perceived difference in contents between such versions, the reference version is the Portable Document Format (PDF). In case of dispute, the reference shall be the printing on ETSI printers of the PDF version kept on a specific network drive within ETSI Secretariat.

Users of the present document should be aware that the document may be subject to revision or change of status. Information on the current status of this and other ETSI documents is available at

<http://portal.etsi.org/tb/status/status.asp>

If you find errors in the present document, send your comment to:

editor@etsi.org

Copyright Notification

No part may be reproduced except as authorized by written permission.
The copyright and the foregoing restriction extend to reproduction in all media.

© European Telecommunications Standards Institute 2003.
All rights reserved.

DECT™, **PLUGTESTS™** and **UMTS™** are Trade Marks of ETSI registered for the benefit of its Members.
TIPHON™ and the **TIPHON logo** are Trade Marks currently being registered by ETSI for the benefit of its Members.
3GPP™ is a Trade Mark of ETSI registered for the benefit of its Members and of the 3GPP Organizational Partners.

Contents

Intellectual Property Rights	9
Foreword.....	9
1 Scope	10
2 References	10
3 Definitions, symbols and abbreviations	12
3.1 Definitions	12
3.2 Symbols.....	13
3.3 Abbreviations	13
4 Overview of CAT	14
4.1 Profile download	14
4.2 Proactive UICC	14
4.3 Data download to UICC	15
4.4 Menu selection	15
4.5 Call control by network access application	15
4.6 Void.....	15
4.7 Event download.....	15
4.8 Security	15
4.9 Multiple card	16
4.10 Timer expiration.....	16
4.11 Bearer Independent Protocol	16
4.12 Description of the access technology indicator mechanism	16
4.13 Tag allocation guidelines.....	17
5 Profile download	17
5.1 Procedure.....	17
5.2 Structure and coding of TERMINAL PROFILE.....	17
5.3 Definition of display parameters in profile download.....	21
5.3.1 Number of characters supported down the terminal display.....	21
5.3.2 Number of characters supported across the terminal display.....	21
5.3.3 Display can be resized	22
5.3.4 Text wrapping	22
5.3.5 Text scrolling.....	22
5.3.6 Width reduction when in a menu	22
6 Proactive UICC	22
6.1 Introduction	22
6.2 Identification of terminal support.....	24
6.3 General procedure	25
6.4 Proactive UICC commands and procedures.....	25
6.4.1 DISPLAY TEXT	25
6.4.2 GET INKEY	27
6.4.3 GET INPUT.....	28
6.4.4 MORE TIME.....	29
6.4.5 PLAY TONE	29
6.4.6 POLL INTERVAL	30
6.4.7 REFRESH.....	30
6.4.8 SET UP MENU	32
6.4.9 SELECT ITEM.....	32
6.4.10 SEND SHORT MESSAGE	33
6.4.11 Void	34
6.4.12 Void	34
6.4.13 SET UP CALL.....	34
6.4.14 POLLING OFF	36
6.4.15 PROVIDE LOCAL INFORMATION	36
6.4.16 SET UP EVENT LIST.....	36

6.4.17	PERFORM CARD APDU	36
6.4.18	POWER OFF CARD	37
6.4.19	POWER ON CARD.....	38
6.4.20	GET READER STATUS.....	38
6.4.21	TIMER MANAGEMENT	38
6.4.22	SET UP IDLE MODE TEXT	39
6.4.23	RUN AT COMMAND	40
6.4.24	SEND DTMF.....	40
6.4.25	LANGUAGE NOTIFICATION	41
6.4.26	LAUNCH BROWSER	41
6.4.27	OPEN CHANNEL.....	42
6.4.27.1	OPEN CHANNEL related to CS bearer.....	42
6.4.27.2	OPEN CHANNEL related to packet data service bearer	43
6.4.27.3	OPEN CHANNEL related to local bearer.....	45
6.4.28	CLOSE CHANNEL.....	46
6.4.29	RECEIVE DATA	47
6.4.30	SEND DATA.....	47
6.4.31	GET CHANNEL STATUS	48
6.4.32	SERVICE SEARCH	48
6.4.33	GET SERVICE INFORMATION	49
6.4.34	DECLARE SERVICE	49
6.5	Common elements in proactive UICC commands	50
6.5.1	Command number	50
6.5.2	Device identities	50
6.5.3	Alpha identifier	50
6.5.4	Icon identifiers	50
6.6	Structure of proactive UICC commands	51
6.6.1	DISPLAY TEXT	51
6.6.2	GET INKEY	51
6.6.3	GET INPUT.....	52
6.6.4	MORE TIME.....	52
6.6.5	PLAY TONE	52
6.6.6	POLL INTERVAL	53
6.6.7	SET-UP MENU	53
6.6.8	SELECT ITEM.....	53
6.6.9	SEND SHORT MESSAGE	54
6.6.10	Void	54
6.6.11	Void	54
6.6.12	SET UP CALL.....	54
6.6.13	REFRESH.....	55
6.6.14	POLLING OFF	55
6.6.15	PROVIDE LOCAL INFORMATION.....	55
6.6.16	SET UP EVENT LIST.....	55
6.6.17	PERFORM CARD APDU	55
6.6.18	POWER OFF CARD	56
6.6.19	POWER ON CARD.....	56
6.6.20	GET READER STATUS.....	56
6.6.21	TIMER MANAGEMENT	56
6.6.22	SET UP IDLE MODE TEXT	56
6.6.23	RUN AT COMMAND	57
6.6.24	SEND DTMF COMMAND.....	57
6.6.25	LANGUAGE NOTIFICATION	57
6.6.26	LAUNCH BROWSER	57
6.6.27	OPEN CHANNEL.....	58
6.6.27.1	OPEN CHANNEL related to CS bearer.....	58
6.6.27.2	OPEN CHANNEL related to packet data service bearer	59
6.6.27.3	OPEN CHANNEL related to local bearer.....	60
6.6.28	CLOSE CHANNEL.....	60
6.6.29	RECEIVE DATA	61
6.6.30	SEND DATA.....	61
6.6.31	GET CHANNEL STATUS	61
6.6.32	SERVICE SEARCH	61

6.6.33	GET SERVICE INFORMATION	61
6.6.34	DECLARE SERVICE	62
6.7	Command results	62
6.8	Structure of TERMINAL RESPONSE	64
6.8.1	Command details	65
6.8.2	Device identities	65
6.8.3	Result	65
6.8.4	Duration	65
6.8.5	Text string	66
6.8.6	Item identifier	66
6.8.7	Local information	66
6.8.8	Call control requested action	66
6.8.9	Result data object 2	67
6.8.10	Card reader status	67
6.8.11	Card ATR	67
6.8.12	R-APDU	67
6.8.13	Timer identifier	67
6.8.14	Timer value	67
6.8.15	AT Response	67
6.8.16	Text string 2	67
6.8.17	Channel data	68
6.8.18	Channel status	68
6.8.19	Channel data length	68
6.8.20	Bearer description	68
6.8.21	Buffer size	68
6.8.22	Total Display Duration	68
6.8.23	Service Availability	68
6.8.24	Service Record	68
6.9	Proactive UICC session and terminal display interaction	69
6.10	Handling of unknown, unforeseen and erroneous messages	69
6.10.1	General	69
6.10.2	Message too short	69
6.10.3	Missing minimum information	69
6.10.4	Unknown Tag value	70
6.10.5	Unexpected Tag value	70
6.10.6	Length errors	70
6.10.7	Contents not understood	70
6.10.8	Extended length data objects	70
6.11	Proactive commands versus possible terminal response	70
7	ENVELOPE commands	73
7.1	Void	73
7.2	Menu selection	73
7.2.1	Procedure	73
7.2.2	Structure of ENVELOPE (MENU SELECTION)	73
7.3	Call Control by NAA	74
7.3.1	Call Control by NAA	74
7.3.1.1	Procedure for mobile originated calls	74
7.3.1.2	Void	74
7.3.1.3	Indication to be given to the user	74
7.3.1.4	Interaction with Fixed Dialling Number (FDN)	75
7.3.1.5	Support of Barred Dialling Number (BDN) service	76
7.3.1.6	Structure of ENVELOPE (CALL CONTROL)	76
7.4	Timer expiration	78
7.4.1	Description	78
7.4.2	Structure of ENVELOPE (TIMER EXPIRATION)	78
7.5	Event download	78
7.5.1	MT call event	79
7.5.1.1	Procedure	79
7.5.1.2	Structure of ENVELOPE (EVENT DOWNLOAD - MT call)	79
7.5.2	Call connected event	80
7.5.2.1	Procedure	80

7.5.2.2	Structure of ENVELOPE (EVENT DOWNLOAD - Call connected)	80
7.5.3	Call disconnected event	81
7.5.3.1	Procedure	81
7.5.3.2	Structure of ENVELOPE (EVENT DOWNLOAD - Call disconnected)	81
7.5.4	Location status event	82
7.5.4.1	Procedure	82
7.5.4.2	Structure of ENVELOPE (EVENT DOWNLOAD - Location status).....	82
7.5.5	User activity event	82
7.5.5.1	Procedure	82
7.5.5.2	Structure of ENVELOPE (EVENT DOWNLOAD - User activity)	83
7.5.6	Idle screen available event.....	83
7.5.6.1	Procedure	83
7.5.6.2	Structure of ENVELOPE (EVENT DOWNLOAD - Idle screen available)	83
7.5.7	Card reader status event.....	84
7.5.7.1	Procedure	84
7.5.7.2	Structure of ENVELOPE (EVENT DOWNLOAD - Card reader status)	84
7.5.8	Language selection event.....	85
7.5.8.1	Procedure	85
7.5.8.2	Structure of ENVELOPE (EVENT DOWNLOAD - Language selection)	85
7.5.9	Browser termination event.....	85
7.5.9.1	Procedure	85
7.5.9.2	Structure of ENVELOPE (EVENT DOWNLOAD - Browser termination)	85
7.5.10	Data available event.....	86
7.5.10.1	Procedure	86
7.5.10.2	Structure of ENVELOPE (EVENT DOWNLOAD - Data available)	86
7.5.11	Channel status event	87
7.5.11.1	Procedure	87
7.5.11.2	Structure of ENVELOPE (EVENT DOWNLOAD - Channel status).....	87
7.5.12	Access technology change event	88
7.5.12.1	Procedure	88
7.5.12.2	Structure of ENVELOPE (EVENT DOWNLOAD - Access Technology Change).....	88
7.5.13	Display parameters changed event.....	88
7.5.13.1	Procedure	88
7.5.13.2	Structure of ENVELOPE (EVENT DOWNLOAD - Display parameters changed).....	89
7.5.14	Local connection event	89
7.5.14.1	Procedure	89
7.5.14.2	Structure of ENVELOPE (EVENT DOWNLOAD - Local Connection).....	89
8	SIMPLE-TLV data objects.....	90
8.1	Address.....	90
8.2	Alpha identifier	91
8.3	Subaddress.....	92
8.4	Capability configuration parameters	92
8.5	Void.....	92
8.6	Command details.....	92
8.7	Device identities	97
8.8	Duration.....	97
8.9	Item	98
8.10	Item identifier	98
8.11	Response length.....	98
8.12	Result.....	99
8.12.1	Void	100
8.12.2	Additional information for terminal problem	100
8.12.3	Additional information for network problem.....	101
8.12.4	Void	101
8.12.5	Void	101
8.12.6	Void	101
8.12.7	Void	101
8.12.8	Additional information for interaction with call control.....	101
8.12.9	Additional information for MultipleCard commands	101
8.12.10	Additional information for launch browser problem	102
8.12.11	Additional information for Bearer Independent Protocol	102

8.13	3GPP- SMS TPDU	102
8.14	Void.....	103
8.15	Text string	103
8.15.1	Coding of text in unpacked format	103
8.15.2	Coding of text in packed format	103
8.15.3	Coding of text in 16 bits UCS2 alphabet format.....	103
8.16	Tone.....	104
8.17	Void.....	104
8.18	File list.....	104
8.19	Location information.....	105
8.20	IMEI	105
8.21	Help request.....	105
8.22	Network measurement results	105
8.23	Default text.....	105
8.24	Items next action indicator	106
8.25	Event list.....	106
8.26	Cause	107
8.27	Location status.....	107
8.28	Transaction identifier	108
8.29	Void.....	108
8.30	Call control requested action	108
8.31	Icon identifier	108
8.32	Item icon identifier list	109
8.33	Card reader status	109
8.34	Card ATR	110
8.35	C-APDU	111
8.36	R-APDU	111
8.37	Timer identifier	111
8.38	Timer value	112
8.39	Date-time and time zone.....	112
8.40	AT command.....	113
8.41	AT response.....	113
8.42	BC repeat indicator.....	113
8.43	Immediate response.....	113
8.44	DTMF string.....	114
8.45	Language	114
8.46	Void.....	114
8.47	Browser identity	114
8.48	URL.....	114
8.49	Bearer	115
8.50	Provisioning file reference	115
8.51	Browser termination cause	115
8.52	Bearer description.....	116
8.53	Channel data.....	116
8.54	Channel data length	117
8.55	Buffer size	117
8.56	Channel status	117
8.57	Card reader identifier.....	118
8.58	Other address.....	118
8.59	UICC/terminal interface transport level	119
8.60	AID.....	119
8.61	Access technology	119
8.62	Display parameters	120
8.63	Service record.....	120
8.64	Device filter.....	122
8.65	Service search.....	122
8.66	Attribute information.....	123
8.67	Service availability	124
8.68	Remote entity address	124
8.69	ESN	125
8.70	Network access name	125
8.71	CDMA-SMS TPDU	125

9	Tag values	125
9.1	BER-TLV tags in terminal to UICC direction.....	125
9.2	BER-TLV tags in UICC TO terminal direction	126
9.3	SIMPLE-TLV tags in both directions	126
9.4	Type of command and next action indicator	127
10	Allowed type of command and device identity combinations	128
11	Security requirements.....	129
Annex A (normative):	Support of CAT by terminal equipment.....	130
Annex B (informative):	Example of DISPLAY TEXT proactive UICC command.....	131
Annex C (normative):	Structure of CAT communications	132
C.1	SIMPLE-TLV tag format	133
C.1.1	Single byte format	133
C.1.2	Three-byte format.....	133
Annex D (informative):	Terminal display in proactive UICC session.....	134
Annex E (informative):	Help information feature processing.....	135
Annex F (informative):	Monitoring of events.....	136
Annex G (normative):	Support of multiple card operation.....	137
Annex H (informative):	Multiple card proactive command examples	138
Annex I (informative):	Bearer independent protocol proactive command examples.....	139
Annex J (informative):	WAP terminology	142
Annex K (informative):	Use of CAT bearer independent protocol for local links Bluetooth case	143
K.1	Service search command	143
K.2	Get service information command	143
K.3	OPEN CHANNEL command.....	144
Annex L (informative):	Bluetooth service discovery protocol.....	146
L.1	Service attribute.....	147
Annex M (informative):	Use of CAT bearer independent protocol for local links, server case	148
Annex N (informative):	Bibliography.....	149
Annex O (informative):	Change history	150
History		151

Intellectual Property Rights

IPRs essential or potentially essential to the present document may have been declared to ETSI. The information pertaining to these essential IPRs, if any, is publicly available for **ETSI members and non-members**, and can be found in ETSI SR 000 314: "*Intellectual Property Rights (IPRs); Essential, or potentially Essential, IPRs notified to ETSI in respect of ETSI standards*", which is available from the ETSI Secretariat. Latest updates are available on the ETSI Web server (<http://webapp.etsi.org/IPR/home.asp>).

Pursuant to the ETSI IPR Policy, no investigation, including IPR searches, has been carried out by ETSI. No guarantee can be given as to the existence of other IPRs not referenced in ETSI SR 000 314 (or the updates on the ETSI Web server) which are, or may be, or may become, essential to the present document.

Foreword

This Technical Specification (TS) has been produced by ETSI Project Smart Card Platform (SCP).

It is based on work originally done in the 3GPP in TSG-terminals WG3.

The contents of the present document are subject to continuing work within EP SCP and may change following formal EP SCP approval. If EP SCP modifies the contents of the present document, it will then be republished by ETSI with an identifying change of release date and an increase in version number as follows:

Version x.y.z

where:

- x the first digit:
 - 0 early working draft;
 - 1 presented to EP SCP for information;
 - 2 presented to EP SCP for approval;
 - 3 or greater indicates EP SCP approved document under change control.
- y the second digit is incremented for all changes of substance, i.e. technical enhancements, corrections, updates, etc.
- z the third digit is incremented when editorial only changes have been incorporated in the document.

1 Scope

The present document defines the interface between the UICC and the terminal, and mandatory terminal procedures, specifically for "NAA Card Application Toolkit".

The Card Application Toolkit (CAT) is a set of generic commands and procedures for use by the ICC, irrespective of the access technology of the network. Within the scope of the present document, the UICC refers here to an ICC which supports at least one application in order to access a network. This application is called here Network Access Application (NAA).

The ICC is considered as a platform, which is either based on TS 102 221 [1], here called "3G platform", or TS 151 011 [8], here called "2G platform".

NAA can be:

- a USIM application, as defined in TS 131 102 [6], which can reside only on a 3G platform;
- a SIM application, as defined in TS 151 011 [8], which can reside either on a 3G or a 2G platform;
- a TSIM application, as defined in TS 100 812 (see bibliography), which can reside only on a 3G platform;
- a RUM application, as defined in TIA/IS-820-A [17], 3GPP2 C.S0023-0 [30], which can reside on a 2G platform; or
- other applications residing on a 3G platform or a 2G platform. Specifying the interface is to ensure interoperability between an ICC and a terminal independently of the respective manufacturers and operators.

The present document specifies as well mechanisms in order to expand the generic set of commands and procedures by access technology specific ones.

The present document defines:

- the commands;
- the application protocol;
- the mandatory requirements on the ICC and terminal for each procedure.

The present document does not specify any aspects related to the administrative management phase. Any internal technical realization of either the ICC or the terminal are only specified where these reflect over the interface. The present document does not specify any of the security algorithms that may be used.

2 References

The following documents contain provisions which, through reference in this text, constitute provisions of the present document.

- References are either specific (identified by date of publication and/or edition number or version number) or non-specific.
- For a specific reference, subsequent revisions do not apply.
- For a non-specific reference, the latest version applies.

Referenced documents which are not found to be publicly available in the expected location might be found at <http://docbox.etsi.org/Reference>.

- [1] ETSI TS 102 221: "Smart cards; UICC-Terminal interface; Physical and logical characteristics".

- [2] ETSI TS 122 001: "Digital cellular telecommunications system (Phase 2+); Universal Mobile Telecommunications System (UMTS); Principles of circuit telecommunication services supported by a Public Land Mobile Network (PLMN) (3GPP TS 22.001)".
- [3] ETSI TS 123 038: "Digital cellular telecommunications system (Phase 2+); Universal Mobile Telecommunications System (UMTS); Alphabets and language-specific information (3GPP TS 23.038)".
- [4] ETSI TS 123 048: "Digital cellular telecommunications system (Phase 2+); Universal Mobile Telecommunications System (UMTS); Security Mechanisms for the (U)SIM application toolkit; Stage 2 (3GPP TS 23.048)".
- [5] ETSI TS 127 007: "Digital cellular telecommunications system (Phase 2+); Universal Mobile Telecommunications System (UMTS); AT command set for 3G User Equipment (UE) (3GPP TS 27.007)".
- [6] ETSI TS 131 102: "Universal Mobile Telecommunications System (UMTS); Characteristics of the USIM Application (3GPP TS 31.102)".
- [7] Void.
- [8] ETSI TS 151 011: "Digital cellular telecommunications system (Phase 2+); Specification of the Subscriber Identity Module - Mobile Equipment (SIM-ME) interface (3GPP TS 51.011)".
- [9] IETF RFC 768: "User Datagram Protocol".
- [10] IETF RFC 793: "Transmission Control Protocol".
- [11] IETF RFC 1738: "Uniform Resource Locators (URL)".
- [12] ISO 639 (1988): "Codes for the representation of names of languages".
- [13] ISO/IEC 7816-3 (1997): "Information technology - Identification cards - Integrated circuit(s) cards with contacts - Part 3: Electronic signals and transmission protocols".
- [14] ISO/IEC 7816-4 (1995): "Information technology - Identification cards - Integrated circuit(s) cards with contacts - Part 4: Interindustry commands for interchange".
- [15] ISO/IEC 7816-6 (1996): "Identification cards - Integrated circuit(s) cards with contacts - Part 6: Interindustry data elements".
- [16] Specification of the Bluetooth system; Volume 2; Profiles of the Bluetooth system.
- NOTE: <http://www.bluetooth.org/>.
- [17] TIA/IS-820-A: "Removable User Identity Module (R-UIM) for TIA/EIA Spread Spectrum Standards".
- [18] ANSI TIA/EIA-41-D: "Cellular Radiotelecommunications Intersystem Operations" (ANSI/TIA/EIA-41-D-97).
- [19] ETSI TS 100 922: "Digital cellular telecommunications system (Phase 2+); Subscriber Identity Modules (SIM); Functional characteristics (GSM 02.17 Release 1999)".
- [20] ETSI TS 124 008: "Digital cellular telecommunications system (Phase 2+); Universal Mobile Telecommunications System (UMTS); Mobile radio interface Layer 3 specification; Core network protocols; Stage 3 (3GPP TS 24.008)".
- [21] Void.
- [22] ITU-T Recommendation E.164: "The international public telecommunication numbering plan".
- [23] ITU-T Recommendation X.121: "International numbering plan for public data networks".
- [24] ITU-T Recommendation F.69: "The international telex service - Service and operational provisions of telex destination codes and telex network identification codes".

- [25] ANSI TIA/EIA-136-C: "TDMA Cellular PCS".
- [26] ETSI TS 131 111: "Digital cellular telecommunications system (Phase 2+); Universal Mobile Telecommunications System (UMTS); USIM Application Toolkit (USAT) (3GPP TS 31.111)".
- [27] ETSI TS 123 040: "Digital cellular telecommunications system (Phase 2+); Universal Mobile Telecommunications System (UMTS); Technical realization of Short Message Service (SMS) (3GPP TS 23.040)".
- [28] ETSI TS 122 030: "Digital cellular telecommunications system (Phase 2+); Universal Mobile Telecommunications System (UMTS); Man-Machine Interface (MMI) of the User Equipment (UE) (3GPP TS 22.030)".
- [29] 3GPP2 C.S0015-0: "Short Message Service (SMS)".
- [30] 3GPP2 C.S0023-0: "Removable User Identity Module".
- [31] ETSI TS 101 220: "Smart Cards; ETSI numbering system for telecommunication application providers (Release 5)".

3 Definitions, symbols and abbreviations

3.1 Definitions

For the purposes of the present document, the following terms and definitions apply:

application: set of security mechanisms, files, data and protocols (excluding transmission protocols)

application protocol: set of procedures required by the application

bearer independent protocol: mechanism by which the terminal provides the UICC with access to the data bearers supported by the terminal and the network

card reader x: electrical interface to support additional card

card session: link between the card and the external world starting with the ATR and ending with a subsequent reset or a deactivation of the card

card x: additional card

Card Application Toolkit (CAT): set of applications and related procedures that may be used during a card session

data channel: allow the UICC and the network to exchange data using a selected bearer

data object: information seen at the interface for which are defined a tag (identifier), a length and a value

NOTE: Data objects can be either BER-TLV (objects that conform to the Basic Encoding Rules of ASN.1) or SIMPLE-TLV. In the present document, all BER-TLV data objects are "primitive": the value part consists only of SIMPLE-TLV data objects.

link: radio resource

network access application: application residing in the UICC which holds a subscriber identity and an authentication algorithm and provides the access to a network

padding: one or more bits appended to a message in order to cause the message to contain the required number of bits or bytes

proactive UICC: UICC which is capable of issuing commands to the terminal

proactive UICC session: sequence of related CAT commands and responses which starts with the status response '91xx' (proactive command pending) and ends with a status response of '90 00' (normal ending of command) after Terminal Response

Rx buffer: dedicated memory used to temporarily store data to be retrieved

Service Data Unit (SDU): set of data in layered systems that is sent by a user of the services of a given layer, and is transmitted to a peer service user semantically unchanged

NOTE: A Protocol Control Information (PCI) header is attached to the Service Data Unit (SDU) by the layer to form a Protocol Data Unit (PDU).

Tx buffer: dedicated memory used to temporarily store data to be sent.

UICC: A smart card that conforms to the specification written and maintained by the ETSI Smart Card Platform project. UICC is neither an abbreviation nor an acronym.

UICC application session: execution of a sequence of commands internal to the UICC that can result in the performance of one or several proactive UICC sessions

NOTE: The UICC application session can be started by any event in the card session, and can execute for the duration of the card session. Processing of the UICC application session will not interfere with normal 3G operation.

3.2 Symbols

For the purposes of the present document, the following symbol applies:

'0' to '9' and 'A' to 'F' The sixteen hexadecimal digits

3.3 Abbreviations

For the purposes of the present document, the following abbreviations apply:

APDU	Application Protocol Data Unit
ATR	Answer To Reset
BCD	Binary Coded Decimal
BD_ADDR	Bluetooth Device ADDRESS
BDN	Barred Dialling Number
BER	Basic Encoding Rules of ASN.1
C-APDU	Command Application Protocol Data Unit
CAT	Card Application Toolkit
CCP	Capability/Configuration Parameter
CoD	Class of Device (Bluetooth related)
CSD	Circuit Switched Data
DTMF	Dual Tone Multiple Frequency
EF	Elementary File
EIA	Electronics Industries Association
ESN	Electronic Serial Number
FDN	Fixed Dialling Number
GSM	Global System for Mobile communications
ID	IDentifier
IEC	International Electrotechnical Commission
IMEI	International Mobile Equipment Identity
IMSI	International Mobile Subscriber Identity
ISO	International Organization for Standardization
lgth	the (specific) length of a data unit
ME	Mobile Equipment
MMI	Man Machine Interface
NAA	Network Access Application
NAI	Next Action Indicator
NMR	Network Measurement Results
NPI	Numbering Plan Identifier
PDN	Packet Data Network
PDP	Packet Data Protocol, e.g. IP or X25 or PPP

PDU	Protocol Data Unit
R-APDU	Response Application Protocol Data Unit
RFU	Reserved for Future Use
RUIM	Removable User Identity Module
SDP	Service Discovery Protocol (Bluetooth related)
SDU	Service Data Unit
SMS	Short Message Service
SW1/SW2	Status Word 1/Status Word 2
TCP	Transmission Control Protocol
TE	Terminal Equipment (e.g. an attached personal computer)
TETRA	TErrestrial TRunked RAdio
TIA	TElecommunications Industries Association
TLV	Tag, Length, Value
TON	Type Of Number
TP	Transfer layer Protocol
TSIM	TETRA SIM application
UCS2	Universal two byte coded Character Set
UDP	User Datagram Protocol
UE	User Equipment
UMTS	Universal Mobile Telecommunication System
URL	Uniform Resource Location

4 Overview of CAT

The CAT provides mechanisms which allow applications, existing in the UICC, to interact and operate with any terminal which supports the specific mechanism(s) required by the application.

If class "a" is supported, a UICC supporting CAT shall be able to communicate with the additional card(s) and get information about the additional reader(s) via the terminal.

The following mechanisms have been defined. These mechanisms are dependent upon the commands and protocols relevant to CAT as USAT in TS 102 221 [1] for a 3G platform and as SAT in TS 151 011 [8] for a 2G platform.

4.1 Profile download

Profile downloading provides a mechanism for the terminal to tell the UICC what it is capable of.

4.2 Proactive UICC

Proactive UICC gives a mechanism whereby the UICC can initiate actions to be taken by the terminal. These actions include:

- displaying text from the UICC to the terminal;
- sending a short message;
- setting up a voice call to a number held by the UICC;
- setting up a data call to a number and bearer capabilities held by the UICC;
- playing tone in earpiece;
- initiating a dialogue with the user;
- NAA network access application initialization request and notification of changes to EF(s);
- providing local information from the terminal to the UICC;
- communicating with the additional card(s) (if class "a" is supported);

- providing information about the additional card reader(s) (if class "a" is supported);
- managing timers running physically in the terminal;
- running an AT command received from the UICC, and returning the result to the UICC (if class "b" is supported);
- sending DTMF;
- requesting the terminal to launch the browser corresponding to a URL (if class "c" is supported);
- establishing and managing a bearer independent protocol (if class "e" is supported).

For each command involved in the dialog with the user, a help information may be available, either for each item of a list of items proposed to the user, or with each command requesting a response from the user. If a proactive command involved in the dialog with the user indicates the availability of the help feature, the support of this feature is optional for the terminal.

4.3 Data download to UICC

Data downloading to the UICC uses either dedicated commands (using the transport mechanisms of the technology) or the Bearer independent protocol. Transferral of information over the UICC-terminal interface uses the ENVELOPE command.

4.4 Menu selection

A set of possible menu entries is supplied by the UICC in a proactive UICC command. The menu selection mechanism is used to transfer the UICC application menu item which has been selected by the user to the UICC. The menu selection mechanism may also be used for requesting help information on the items of the UICC application menu.

4.5 Call control by network access application

When this service is activated by the NAA, all dialled digit strings, are first passed to the UICC before the terminal sets up the call. The terminal shall also pass to the UICC at the same time its current serving cell. The toolkit application has the ability to allow, bar or modify the call. The application also has the ability to replace a call request by another call request.

NOTE: In some technologies, the call request can even be replaced by another operation, for instance USSD or SMS in GSM/3GPP.

4.6 Void

4.7 Event download

A set of events to monitor for is supplied by the UICC in a proactive UICC command. The event download mechanism is used to transfer details of the event to the UICC, when it occurs. Events that the terminal can report to the UICC include incoming calls, location status, access technology, display parameters changed, and availability of the screen for applications.

4.8 Security

Applications designed using the features in the present document may require methods to ensure data confidentiality, data integrity, and data sender validation, or any subset of these. Requirements for these mechanisms are defined in clause 11.

4.9 Multiple card

This clause applies if class "a" is supported.

One event and a set of proactive commands are supplied to monitor and control Card x behaviour.

4.10 Timer expiration

The UICC is able to manage timers running physically in the terminal with a proactive command. The timer expiration mechanism is used to inform the UICC when a timer expires.

4.11 Bearer Independent Protocol

The following paragraph applies if class "e" is supported.

The set of proactive commands (OPEN CHANNEL, CLOSE CHANNEL, SEND DATA, RECEIVE DATA, and GET CHANNEL STATUS) and events (Data available, Channel status) allows the UICC to establish a data channel with the terminal, and through the terminal either to a remote Server in the Network or to a remote device in the Personal Area Network. The UICC provide information for the terminal to select an available bearer at the time of channel establishment. The terminal then allows the UICC and the Server to exchange data on this channel, transparently. The UICC uses service of terminal lower layer to send data by providing Service Data Unit to terminal. The default lower layer is the higher layer of selected bearer.

The following paragraphs apply if class "f" is supported.

The proactive command SERVICE SEARCH allows the UICC to look for services available on remote devices. The proactive command GET SERVICE INFORMATION allows the UICC to get detailed information regarding one service.

The proactive command DECLARE SERVICE allows the UICC to add or delete a service to the terminal service database. The event Local Connection allows to inform the UICC of a connection request on a local bearer.

4.12 Description of the access technology indicator mechanism

This clause describes the mechanisms that can be employed to indicate access technology specific dependencies in a multi-access technology environment.

There are cases where toolkit applications need to know which access technology the terminal is currently in so that it can issue access technology dependent commands as well as determine that the response to a particular command is technology dependent. Setting up the event, ACCESS TECHNOLOGY CHANGE, and its continuous monitoring, provides a means by which the terminal can inform the toolkit application of a change in the current access technology. This change is notified to the toolkit application via the ENVELOPE command: EVENT DOWNLOAD - "Access Technology Change" together with the new access technology.

Additionally, the proactive command, PROVIDE LOCAL INFORMATION, can be used to provide an access technology indication. This is achieved by the toolkit application using the Access Technology command qualifier in the PROVIDE LOCAL INFORMATION command to which the terminal responds with the current access technology using the TERMINAL RESPONSE message.

In a multi-access technology environment there are some services that are access technology specific (e.g. the SEND USSD proactive command is used in GSM/UTRAN only). In such cases, if the toolkit application issues such a proactive command then the permanent result, "Access Technology unable to process command" is used by the terminal to inform the toolkit application that the requested command could not be performed due to access technology dependencies. Here the toolkit application should not re-issue the command whilst within the same access technology, as the result will be the same, however, it may re-issue the command when in another access technology.

4.13 Tag allocation guidelines

This clause defines some guidelines that should be followed when requesting tag values for both BER TLV and Simple TLV tags. The present document shall be the repository for technology dependent and independent tag values.

An existing tag value shall be reused in the following cases:

- if an object is common across all access technologies and it has the same coding (e.g. Text String tag, Timer Value tag);
- if an object is common across access technologies but the coding of the data is both access technology specific and only valid for the currently employed access technology (e.g. Network Measurement Results tag, Bearer tag). The toolkit application shall use access technology indication procedures to determine the interpretation of the object.

A new tag value shall be allocated in the following cases:

- if the object is unique to one particular access technology (e.g. USSD String tag);
- if an object is common across access technologies but the coding of the data is both access technology specific and always available irrespective of the current access technology (e.g. IMEI tag).

5 Profile download

5.1 Procedure

The profile download instruction is sent by the terminal to the UICC as part of the UICC initialization procedure. This procedure is specified in TS 102 221 [1] for a 3G platform and in TS 151 011 [8] for a 2G platform. The profile sent by the terminal shall state the facilities relevant to CAT that are supported by the terminal.

This procedure is important, as it allows the UICC to determine what the terminal is capable of, and the UICC can then limit its instruction range accordingly. If no command is sent by the terminal, the UICC shall assume that the terminal does not support CAT.

5.2 Structure and coding of TERMINAL PROFILE

Direction: terminal to UICC.

The command header is specified in TS 102 221 [1] for a 3G platform and in TS 151 011 [8] for a 2G platform.

Command parameters/data:

Description	Clause	M/O/C	Length
Profile	-	M	lgth

Profile:

- Contents:
 - The list of CAT facilities that are supported by the terminal.
- Coding:
 - 1 bit is used to code each facility:
 - bit = 1: facility supported by terminal;
 - bit = 0: facility not supported by terminal.

First byte (Download):

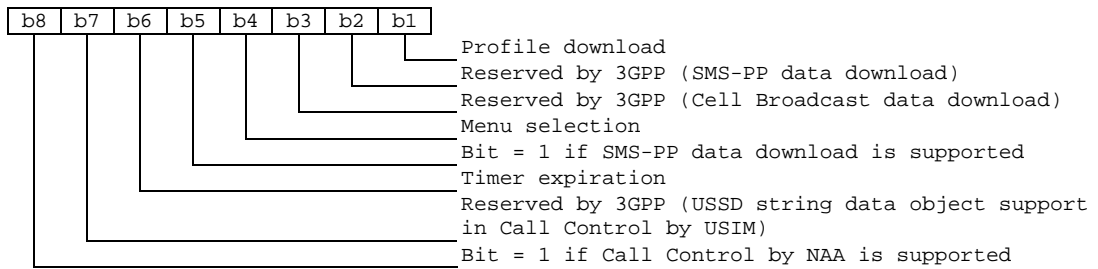

Second byte (Other):

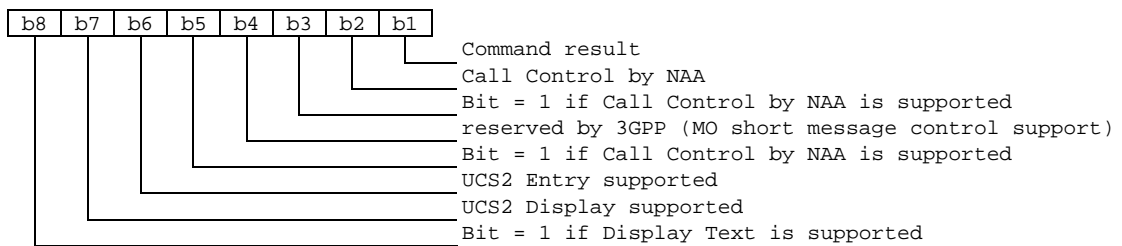

Third byte (Proactive UICC):

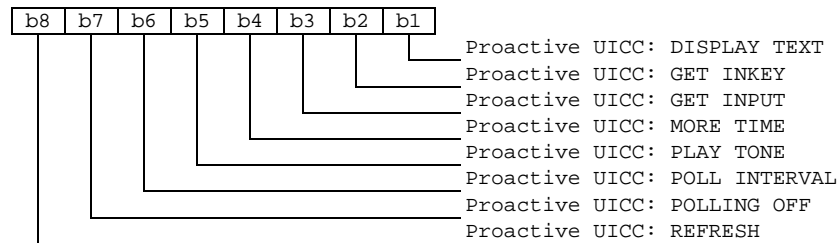

Fourth byte (Proactive UICC):

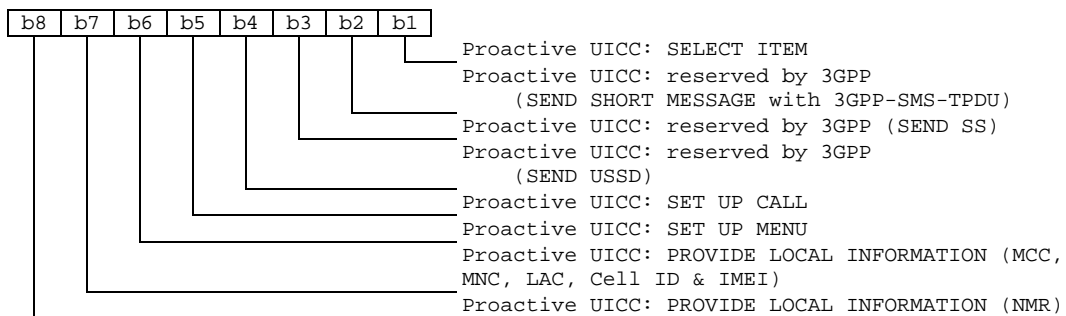

Fifth byte (Event driven information):

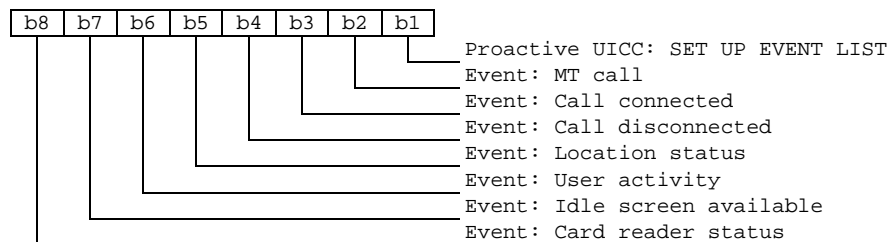

Sixth byte (Event driven information extensions):

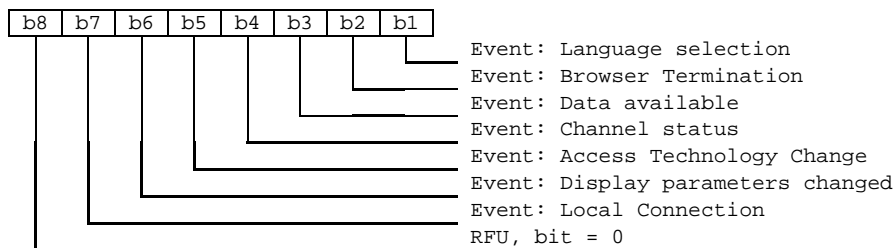

Seventh byte (Multiple card proactive commands) for class "a":

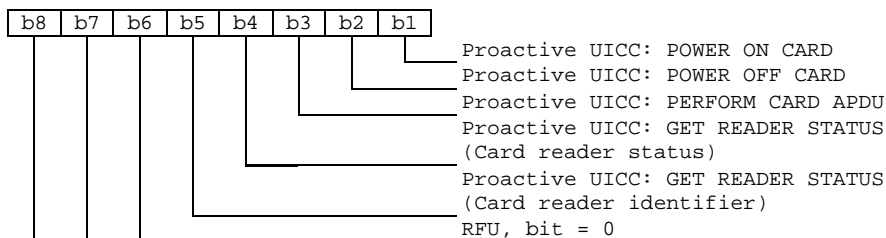

Eighth byte (Proactive UICC):

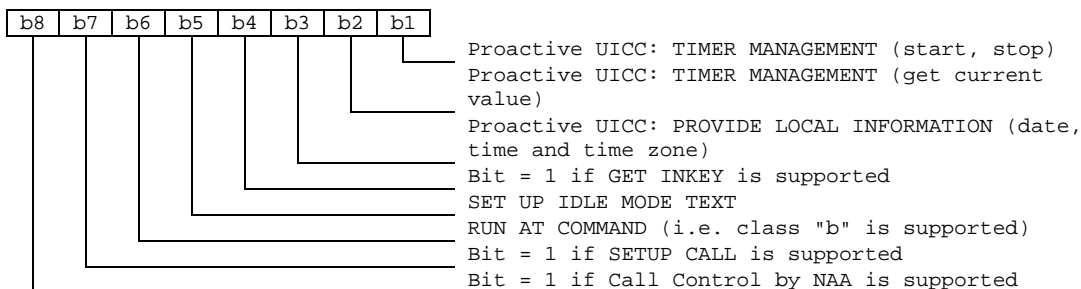

Ninth byte:

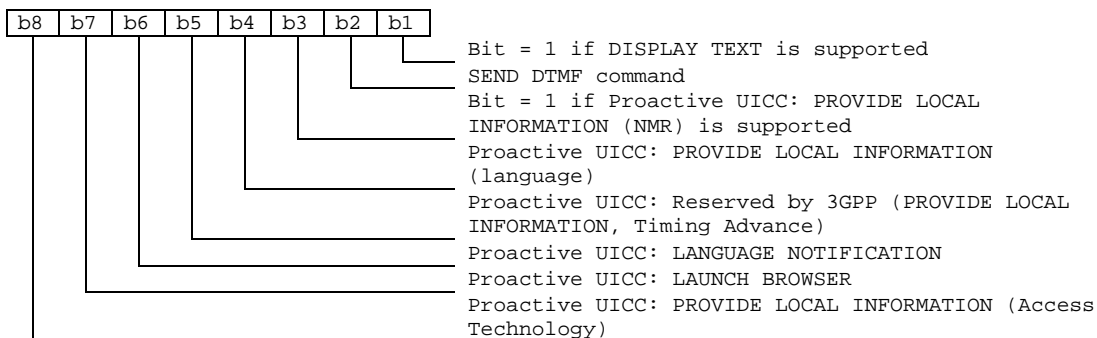

Tenth byte (Soft keys support) for class "d":

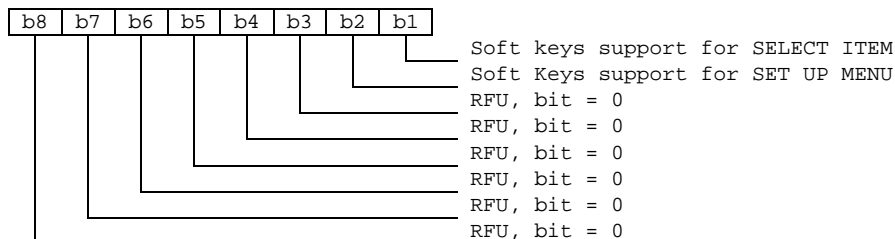

Eleventh byte: (Soft keys information)

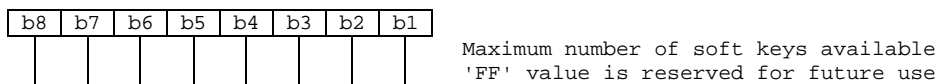

Twelfth byte:

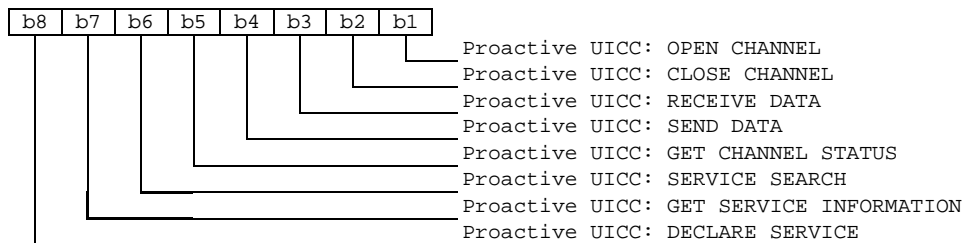

Thirteenth byte:

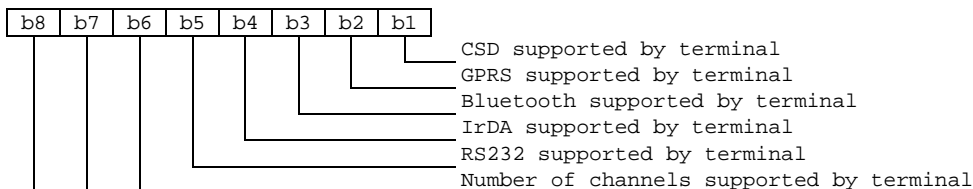

Fourteenth byte: (Screen height)

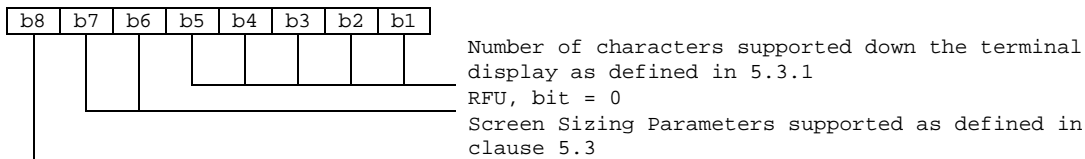

Fifteenth byte: (Screen width)

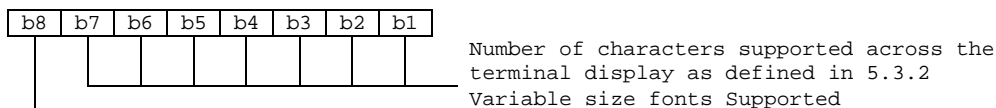

Sixteenth byte: (Screen effects)

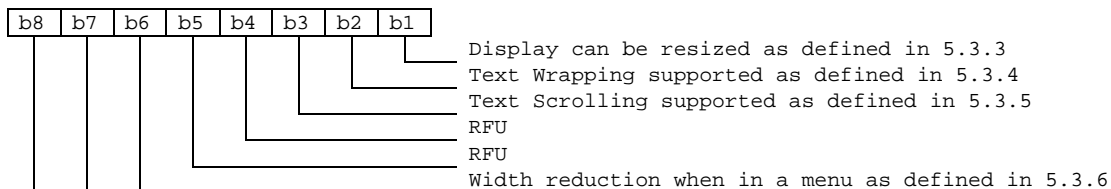

Seventeenth byte:

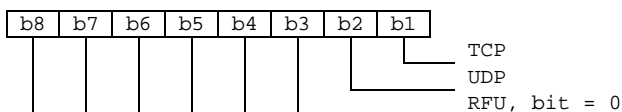

Eighteenth byte:

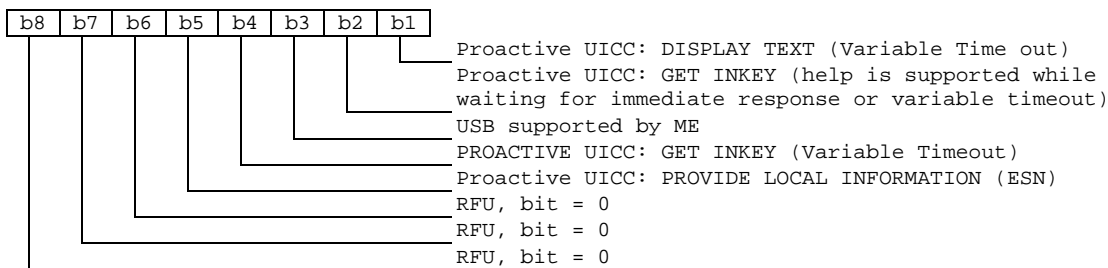

Nineteenth byte: (reserved for TIA/EIA-136 facilities [25]):

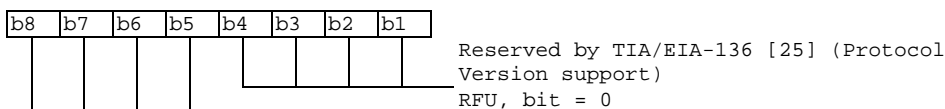

Twentieth byte: (reserved for TIA/EIA/IS-820 facilities [17]):

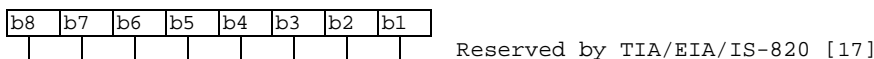

Subsequent bytes:

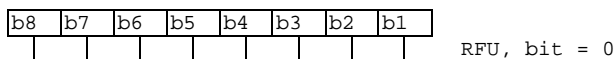

- RFU bits, and all bits of subsequent bytes, are reserved to indicate future facilities. A UICC supporting only the features of Card Application Toolkit defined here shall not check the value of RFU bits.
- Response parameters/data:
 - None.

5.3 Definition of display parameters in profile download

This clause defines the terms used for defining the passing of the terminal's screen parameters from the terminal to the UICC.

5.3.1 Number of characters supported down the terminal display

This is the guaranteed number of characters supported down the terminal display without scrolling (using the default character set specified in TS 123 038 [3]) as a result of a Display Text Proactive command.

If the screen resized as defined in clause 5.3.3 then this value shall be the initial number of characters supported before the display can be resized.

5.3.2 Number of characters supported across the terminal display

This is the guaranteed number of characters supported across the terminal display without scrolling (using the default character set specified in TS 123 038 [3]) as a result of a Display Text Proactive command that can be viewed in one instance.

If the screen resized as defined in clause 5.3.3 then this value shall be the initial number of characters supported before the display can be resized.

5.3.3 Display can be resized

Display resize is supported if either:

- the user can change the number of characters supported across the display, down the display or both;
- the terminal can dynamically change the number of characters supported across the display, down the display or both.

5.3.4 Text wrapping

Text wrapping is supported if the terminal puts words that would be split across two lines, due to the display size, at the beginning of the next line down.

5.3.5 Text scrolling

Text scrolling is supported if the terminal scrolls, on one line, words that would be split across two lines, due to the display size.

5.3.6 Width reduction when in a menu

This value is the number of characters available across the display due to a DISPLAY TEXT proactive command without scrolling (using the default character set specified in TS 123 038 [3]) minus the number of characters available across the display due to a SELECT ITEM proactive command without scrolling (using the default character set specified in TS 123 038 [3]).

If the screen resized as defined in clause 5.3.3, then this value shall be calculated using the initial number of characters supported before the display can be resized.

6 Proactive UICC

6.1 Introduction

TS 102 221 [1], the 3G platform, defines that the terminal communicates to the UICC using the T=0 or T=1 protocols, which are specified in ISO/IEC 7816-3 [13]. The terminal is always the "master" and initiates commands to the UICC, and therefore there is no mechanism for the UICC to initiate a communication with the terminal. This limits the possibility of introducing new UICC features requiring the support of the terminal, as the terminal needs to know in advance what actions it should take.

TS 151 011 [8], the 2G platform, defines that the terminal communicates to the SIM using the T=0 protocol, which is specified in ISO/IEC 7816-3 [13].

The UICC shall execute all CAT Proactive commands or procedures in such a way as not to jeopardize, or cause suspension, of service provisioning to the user. This could occur if, for example, execution of INTERNAL AUTHENTICATE is delayed by internal CAT activity, which would result in the network denying or suspending service to the user. Specifically, the MORE TIME command shall be used, whenever possible, to allow the terminal access to the 3G or 2G functionality of the UICC if a CAT application is taking an unreasonable amount of time to complete execution.

NOTE: The maximum work waiting time without sending a MORE TIME command depends on several factors (e.g. the permissible duration of a network-UICC authentication); in some cases as little as 2 seconds could be required. During this period the UICC should respect the work waiting time procedure, defined in TS 102 221 [1] and TS 151 011 [8].

The proactive UICC service provides a mechanism which stays within the T=0 and T=1 protocols, but adds a new status response word SW1. This status response has the same meaning as the normal ending ('90 00'), and can be used with most of the commands that allow the normal ending, but it also allows the UICC to say to the terminal "I have some information to send to you". The terminal then uses the FETCH function to find out what this information is.

To avoid cross-phase compatibility problems, these functions shall only be used between a proactive UICC and a terminal that supports proactive UICC commands (see clause 6.2).

The UICC can issue a variety of commands through this mechanism, given in alphabetical order:

- **CLOSE CHANNEL:** which requests the terminal to close the specified data channel (if class "e" is supported);
- **DECLARE SERVICE:** which requests the terminal to add or remove a service from its service database (the list of the resources available through a local bearer) (if class "f" is supported);
- **DISPLAY TEXT:** which displays text or an icon on screen. A high priority is available, to replace anything else on screen;
- **GET CHANNEL STATUS:** which requests the terminal to return the current status of all available data channels (if class "e" is supported);
- **GET INKEY:** which sends text or an icon to the display and requests a single character response in return. It is intended to allow a dialogue between the UICC and the user, particularly for selecting an option from a menu;
- **GET INPUT:** which sends text or an icon to the display and requests a response in return. It is intended to allow a dialogue between the UICC and the user;
- **GET READER STATUS:** which gives information about the additional reader(s) and inserted card(s) (Card x state, e.g. powered on or not, Card x Presence), if class "a" is supported;
- **GET SERVICE INFORMATION:** which requests the terminal to look for detailed information on a given service on a given device (if class "f" is supported);
- **LANGUAGE NOTIFICATION:** which allows the UICC to notify the terminal about the currently used language in text strings issued by the CAT application;
- **LAUNCH BROWSER:** which requests a browser inside a browser enabled terminal to interpret the content corresponding to an URL;
- **MORE TIME:** which does not request any action from the terminal. The terminal is required to respond with **TERMINAL RESPONSE (OK)** as normal - see below. The purpose of the **MORE TIME** command is to provide a mechanism for the CAT task in the UICC to request more processing time;
- **OPEN CHANNEL:** which requests the terminal to open a data channel with parameters indicated in the command (if class "e" is supported);
- **PERFORM CARD APDU:** which requests the terminal to send an APDU command to the additional card, if class "a" is supported. This command is compatible with any protocol between the terminal and the additional card;
- **PLAY TONE:** which requests the terminal to play a tone in its earpiece, ringer, or other appropriate loudspeaker;
- **POLL INTERVAL:** which negotiates how often the terminal sends **STATUS** commands to the UICC during idle mode. Polling is disabled with **POLLING OFF**. Use of **STATUS** for the proactive UICC is described in TS 102 221 [1] for 3G platform and in TS 151 011 [8] for a 2G platform;
- **POWER OFF CARD:** which closes the session with the additional card, if class "a" is supported;
- **POWER ON CARD:** which initiates a session with the additional card and returns all the ATR bytes, if class "a" is supported;
- **PROVIDE LOCAL INFORMATION:** which requests the terminal to pass local information to the UICC, for example the mobile country and network codes (MCC + MNC) of the network on which the user is registered;
- **RECEIVE DATA:** which requests the terminal to return to the UICC data received on the specified channel (if class "e" is supported);

- **REFRESH:** which requests the terminal to carry out an initialization, and/or advises the terminal that the contents or structure of EFs on the UICC have been changed. The command also makes it possible to restart a card session by resetting the UICC;
- **RUN AT COMMAND:** which will convey an AT Command to the terminal, and cause the response to the AT Command to be returned to the UICC;
- **SELECT ITEM:** where the UICC supplies a list of items, and the user is expected to choose one. The terminal presents the list in an implementation-dependent way;
- **SEND DATA:** which requests the terminal to send on the specified channel data provided by the UICC (if class "e" is supported);
- **SEND DTMF:** which requests the terminal to send DTMF tone(s) during an established call;
- **SEND SHORT MESSAGE:** which sends a short message or SMS-COMMAND to the network;
- **SERVICE SEARCH:** which requests the terminal to look for services available in the terminal environment (if class "f" is supported);
- **SET UP CALL:** of which there are three types:
 - set up a call, but only if not currently busy on another call;
 - set up a call, putting all other calls (if any) on hold;
 - set up a call, disconnecting all other calls (if any).
- **SET UP EVENT LIST:** where the UICC supplies a list of events which it wants the terminal to provide details of when these events happen;
- **SET UP IDLE MODE TEXT:** which supplies a text string to be used by the terminal as stand-by mode text;
- **SET UP MENU:** where the UICC supplies a list of items to be incorporated into the terminal's menu structure;
- **TIMER MANAGEMENT:** which requests the terminal to manage a timer in a way described in the command (start, deactivate and get the current value) and, in the case of starting a timer, for a duration indicated in the command.

The terminal tells the UICC if the command was successful or not using the command result procedure defined in clause 6.7. Responsibility for what happens after that (whether to repeat the command, try another one immediately, try again sometime later, or not to try again at all) lies with the CAT. However, the CAT needs to know why the command failed, so the terminal provides the UICC with the result of the command.

Results are grouped into three main types:

- OK;
- temporary problem. These results are further broken down into types of temporary problems, and specific causes. Generally, they indicate to the UICC that it may be worth trying again;
- permanent problem. These results are again further broken down into types of permanent problems, and specific causes. Generally, they indicate to the UICC that it is not worth trying again during this card session.

If the UICC issues an instruction to the terminal to initiate a terminal Originated transaction (e.g. SEND SMS, SEND DTMF), then unless explicitly stated elsewhere in the present document or in TS 102 221 [1] or TS 151 011 [8], the content supplied by the UICC for onward transmission by the terminal shall not be altered by the terminal.

6.2 Identification of terminal support

A terminal that supports proactive UICCs shall be identified as such when it sends a **TERMINAL PROFILE** command during UICC initialization. A proactive UICC shall not send any command requests (status bytes SW1 SW2 = '91 XX') to a terminal that does not support the proactive UICC feature.

6.3 General procedure

For all of the procedures that can end in '90 00' (indicating normal ending to the command) a proactive UICC operating with a terminal that supports proactive UICCs may instead use the status response '91 XX'.

The response code '91 XX' shall indicate to the terminal that the previous command has been successfully executed by the UICC in the same way as '90 00' (i.e. "OK"), but additionally it shall indicate response data which contains a command from the UICC for a particular terminal procedure (as defined in clause 6.4).

The value 'XX' indicates the length of the response data. The terminal shall use the FETCH command to obtain this data.

It is the responsibility of the UICC to remind the terminal of a pending proactive command by applying the '91 XX' return code until it is fetched by the terminal.

NOTE 1: The last value of 'XX' received in a '91 XX' return code from the UICC should be used by the terminal in a following FETCH command.

NOTE 2: It is recommended that the terminal interprets a '90 00' following a '91 XX' without a corresponding FETCH as if no proactive command is available in the UICC and regard the proactive UICC session as being terminated. However, the UICC should be able to handle a FETCH command being sent in this case, e.g. by applying the appropriate error handling (cf. "Handling of unknown, unforeseen and erroneous messages").

TS 102 221 [1] and TS 151 011 [8] show how the UICC and the SIM can initiate a proactive command.

When the terminal has received a command from the UICC, it shall attempt to process the command immediately:

- if the command has been successfully executed, the terminal shall inform the UICC as soon as possible, using TERMINAL RESPONSE;
- if the command was not successfully executed, the terminal shall inform the UICC as soon as possible using TERMINAL RESPONSE with an error condition.

Responsibility for re-trying lies with the UICC application. The CAT can make a judgement whether to send the same command again, to send a different one, or not to try again, from the information given by the terminal in TERMINAL RESPONSE. If the UICC application wishes the terminal to try again, it shall issue a new (identical) command.

Only one proactive command can be ongoing at any one time.

6.4 Proactive UICC commands and procedures

6.4.1 DISPLAY TEXT

This command instructs the terminal to display a text message, and/or an icon (see clause 6.5.4). It allows the UICC to define the priority of that message, and the text string format.

Two types of priority are defined:

- display normal priority text and/or icon on screen;
- display high priority text and/or icon on screen.

The text string can be in one of three formats:

- packed format in SMS default alphabet (see clause 8.15.2);
- unpacked format in SMS default alphabet (see clause 8.15.2);
- UCS2 alphabet format (see clause 8.15.3).

NOTE 1: The text string may contain up to 240 bytes.

A flag (see command qualifier, clause 8.6) shall be set to inform the terminal whether the availability of the screen for subsequent information display after its use for "Display Text" should be either after a short delay (the duration of the delay being at the discretion of the terminal manufacturer unless an exact duration is indicated by a duration object), or following a user MMI action.

An immediate response object may be included by the UICC, to indicate if the terminal should sustain the display beyond sending the TERMINAL RESPONSE. Terminal support of this feature is indicated in the PROFILE DOWNLOAD. The behaviour of non-supporting MEs is dependent on the Comprehension Required flag.

A duration object that represents the variable display timeout may be included by the UICC. The duration informs the ME about the required duration of the display (Precision and resolution are in accordance with clause 6.4.21 Timer Management). The requested timeout value replaces the timeout set by the terminal manufacturer. Terminal support of this feature is indicated in the PROFILE DOWNLOAD. The behaviour of terminals that do not support this feature is dependent on the Comprehension Required flag:

- if the user has indicated the need to end the proactive UICC application session, the terminal shall send a TERMINAL RESPONSE with "Proactive UICC application session terminated by the user" result value;
- if the user has indicated the need to go backwards in the proactive UICC application session, the terminal shall send a TERMINAL RESPONSE with "Backward move in the proactive UICC session requested by the user" result value;
- if a flag of the command qualifier (see clause 8.6) indicates that the terminal shall wait for the user to clear message and if the terminal decides that no user response has been received, the terminal shall send a TERMINAL RESPONSE with "No response from user" result value;
- if the UICC includes a duration object, the terminal shall limit the display time of the message for a period that does not exceed the requested duration. The timer starts when the text is displayed on the screen and stops when the TERMINAL RESPONSE is sent except if the text is to be sustained beyond an immediate response. The timeout may be used with other options of this command. The variable timeout does not affect TERMINAL RESPONSE values that are deriving from other chosen options of this command;
- if the UICC includes an immediate response object, the terminal shall immediately send TERMINAL RESPONSE (Command performed successfully). The terminal shall continue to display the text until one of the following events occurs:
 - a subsequent proactive command is received containing display data;
 - the expiration of the variable display timeout, if so indicated by the duration object;
 - the expiration of the short delay, if so indicated by the command qualifier;
 - following a user MMI action;
 - when a higher priority event occurs, e.g. an incoming mobile terminated call;
- no further TERMINAL RESPONSE shall be sent when the terminal removes the text from the display, regardless of the cause;
- otherwise, the terminal shall send TERMINAL RESPONSE (Command performed successfully) at the expiration of either the short delay or the variable display timeout, or following a user MMI action not described above.

In each case the availability of the screen for the subsequent information display is defined in clause 6.9.

NOTE 2: For the case where the text is cleared after a short delay, the terminal may also allow the user to clear the display via the MMI prior to this.

The terminal shall reject normal priority text commands if the screen is currently being used for more than its normal stand-by display. If the command is rejected, the terminal informs the UICC using TERMINAL RESPONSE (terminal currently unable to process command - screen busy).

High priority text shall be displayed on the screen immediately, except if there is a conflict of priority level of alerting such as incoming calls or a low battery warning. In that situation, the resolution is left to the terminal. If the command is rejected in spite of the high priority, the terminal shall inform the UICC using TERMINAL RESPONSE (terminal currently unable to process command - screen is busy).

If help information is requested by the user, this command may be used to display help information on the screen. The help information should be sent as high priority text and with the option that it should be cleared after a short delay.

6.4.2 GET INKEY

This command instructs the terminal to display text and/or an icon (see clause 6.5.4) and to expect the user to enter a single character. Any response entered by the user shall be passed transparently by the terminal to the UICC.

The text can be in one of three formats:

- packed format in SMS default alphabet (see clause 8.15.2);
- unpacked format in SMS default alphabet (see clause 8.15.2);
- UCS2 alphabet format (see clause 8.15.3).

The response can be from one of three character sets. This is specified by the UICC:

- digits only (0-9, *, #, and +);
- characters from the SMS default alphabet;
- characters from the UCS2 alphabet.

Upon receiving the command, the terminal shall display the text. The terminal shall allow the user to enter a single character in response:

- if the user has indicated the need to go backwards in the proactive UICC session, the terminal shall send a TERMINAL RESPONSE with "Backward move in the proactive UICC session requested by the user" result value;
- if the user has indicated the need to end the proactive UICC session, the terminal shall send a TERMINAL RESPONSE with "Proactive UICC session terminated by the user" result value;
- if the terminal decides that no user response has been received, the terminal shall send a TERMINAL RESPONSE with "No response from user" result value;
- if the UICC requests an immediate digit response, the terminal shall only allow the user to enter a character that can be entered by a single key press (that means for terminals providing only the keypad as defined in TS 122 030 [28], from the digits 0 to 9, * and # (but not +)). When the user has entered a digit, the terminal shall pass the entered digit transparently to the UICC, using TERMINAL RESPONSE. The terminal shall not display the entered digit in any way. The terminal shall not allow the user to change the entered digit. The terminal shall not request the user to confirm the response.

NOTE 1: A larger portion of the screen may be used for display purposes, since the terminal shall not display the entered digit in any way.

- if the UICC requests a digit only, the terminal shall only allow the user to enter a character from the digits 0 to 9, *, # and +. When the user has entered a digit, the terminal shall pass the entered digit transparently to the UICC, using TERMINAL RESPONSE;
- if help information is available for the command and if the user has indicated the need to get help information, the terminal shall send a TERMINAL RESPONSE with "help information required by the user" result value. Depending of terminal implementation, combination with the option "immediate response" and/or the option "variable timeout" may result that the user is unable to request the help;
- the terminal support of help information combined with immediate response and/or timeout is indicated in the TERMINAL PROFILE;

- if the UICC requests a character from the SMS default alphabet, the terminal shall allow the user to enter a character using characters from this alphabet. When the user has entered a character, the terminal shall pass the entered character transparently to the UICC, using TERMINAL RESPONSE;
- if the UICC requests a "Yes/No" response, the terminal shall allow the user to enter either a positive or a negative decision using MMI means left to terminal manufacturer's choice (keypad, touch screen, softkey, etc.). The terminal may use SEND, ACCEPT or END functions in relation to GET INKEY "Yes/No" response. If used, the SEND and ACCEPT functions as defined in TS 122 030 [28] shall mean positive decision and the END function as defined in TS 122 030 [28] shall mean a negative one. Depending on the user's choice, the terminal shall pass the positive or a negative value to the UICC, using TERMINAL RESPONSE;
- if the UICC requests a "Yes/No" response together with immediate digit response, the terminal shall combine the behaviour of "Yes/No" UICC request with the behaviour of an immediate digit response UICC request;
- if the UICC requests a variable timeout, the terminal shall wait until either the user enters a single character or the timeout expires. The timer starts when the text is displayed on the screen and stops when the TERMINAL RESPONSE is sent. The terminal shall pass the total display text duration (command execution duration) to the UICC using the TERMINAL RESPONSE. The time unit of the response is identical to the time unit of the requested variable timeout. The timeout may be used with other options of this command. The variable timeout does not affect TERMINAL RESPONSE values that are deriving from other chosen options of this command. terminal support of this feature is indicated in the PROFILE DOWNLOAD. The behaviour of terminals that do not support this feature is dependent on the Comprehension Required flag.

NOTE 2: If the MMI of the terminal requires more than one key press in order to select a character, it is an implementation decision for the terminal manufacturer how to indicate completion (e.g. timeout, pressing SEND, OK). It may be useful to echo the input character on the display.

For digits only (0 to 9, *, # and +) and SMS default alphabet characters sets, the response shall be coded using the SMS default alphabet in unpacked format.

6.4.3 GET INPUT

This command instructs the terminal to display text and/or an icon (see clause 6.5.4) and that any response string entered by the user shall be passed transparently by the terminal to the UICC. If the UICC provides a default text, the terminal shall display this default text, which the user may accept, reject or edit as the response string.

The text can be in one of three formats:

- packed format in SMS default alphabet (see clause 8.15.2);
- unpacked format in SMS default alphabet (see clause 8.15.2);
- UCS2 alphabet format (see clause 8.15.3).

The UICC indicates how many characters are expected for the response string, by giving a minimum and a maximum acceptable length.

The UICC specifies the following variables for the response string it is expecting from the user:

- the response contains either digits only (0-9, *, # and +) or characters from one of the possible alphabets;
- the response contains either characters coded in SMS default alphabet or characters coded in UCS2 alphabet;
- the response for digits only (0-9, *, # and +) or characters from SMS default alphabet is either in an unpacked format or in a packed format;
- the terminal may display the text string being entered by the user (the response), or the terminal shall hide the actual text string.

The combination of characters from either the SMS default alphabet or the UCS2 alphabet and hidden entry mode is not allowed. In hidden entry mode, only digits from the set "0-9", "*" and "#" are allowed for the user input. "+" is not allowed for user input in this mode.

If the UICC requests that the user input (text string) is to be hidden, the terminal shall prevent the text string from being identified by any means. For example, the text string shall not be displayed and no DTMF tones shall be emitted. Nevertheless, it is permissible for the terminal to indicate the entry of characters, so long as the characters themselves are not revealed.

Upon receiving the command, the terminal shall display the text. The terminal shall allow the user to enter characters in response:

- the terminal MMI is responsible for managing the entry of the correct number of characters;
- if the user has indicated the need to go backwards in the proactive UICC session, the terminal shall send a TERMINAL RESPONSE with "Backward move in the proactive UICC session requested by the user" result value;
- if the user has indicated the need to end the proactive UICC session, the terminal shall send a TERMINAL RESPONSE with "Proactive UICC session terminated by the user" result value;
- if the terminal decides that no user response has been received, the terminal shall send a TERMINAL RESPONSE with "No response from user" result value;
- if the UICC requests digits only, the terminal shall only allow the user to enter the digits 0-9, *, # and +. When the user has indicated completion, the terminal shall pass the entered digit string transparently to the UICC, using TERMINAL RESPONSE;
- if the UICC requests characters from the UCS2 alphabet or SMS default alphabet, the terminal shall allow the user to enter a character string using characters from one of these alphabets. When the user has indicated completion, the terminal shall pass the entered text string transparently to the UICC, using TERMINAL RESPONSE;
- if help information is available for the command and if the user has indicated the need to get help information, the terminal shall send a TERMINAL RESPONSE with "help information required by the user" result value;
- if the UICC requests the user input to be in packed format, then the terminal shall pack the text according to TS 123 038 [3] before submitting it to the UICC.

6.4.4 MORE TIME

This procedure is provided to allow the CAT task in the UICC more time for processing, where the processing is so long that it is in danger of affecting normal operation, and clock stop prevents processing to take place in the background.

The terminal shall take no extraordinary action when it receives this command, and all other operations shall be unaffected. The terminal shall conclude the command by sending TERMINAL RESPONSE (OK) to the UICC, as soon as possible after receiving the MORE TIME command.

6.4.5 PLAY TONE

This command instructs the terminal to play an audio tone.

Upon receiving this command, the terminal shall check if it is currently in, or in the process of setting up (SET-UP message sent to the network, see TS 124 008 [20]), a speech call:

- if the terminal is in, or is setting up a speech call, it shall superimpose the tone on top of the downlink audio (if any), for the duration given in the command. The progress or current state of the call shall not be affected in any way. The terminal shall send the TERMINAL RESPONSE (Command performed successfully) as soon as possible after the tone has been completed and, if an alpha identifier was included and displayed, the screen is available for subsequent information display;
- if the terminal is not in or setting up a speech call, it shall route the audio to the external ringer, or other appropriate audio device, and play the tone for the duration given in the command. The terminal shall send the TERMINAL RESPONSE (Command performed successfully) as soon as possible after the tone has been completed and, if an alpha identifier was included and displayed, the screen is available for subsequent information display;

- if the user has indicated the need to end the proactive UICC application session while the terminal plays the tone, the terminal shall stop playing the tone and shall send a TERMINAL RESPONSE with "Proactive UICC application session terminated by the user" result value;
- if terminal support for the specific tone requested is optional, and the terminal does not support this particular tone, the terminal shall inform the UICC using TERMINAL RESPONSE (Command beyond terminal's capabilities).

This proactive command contains no information on how a call is progressing; therefore the terminal shall not generate any verbal indication or display any text or graphical indication about the normal meaning of this tone (e.g. display "called subscriber busy"). If the UICC wishes to convey a meaning in text to the user, it shall do this through the alpha identifier data object and/or an icon (see clause 6.5.4).

The use of this alpha identifier by the terminal is described below:

- if the alpha identifier is provided by the UICC and is not a null data object, the terminal shall use it to inform the user. If an icon is provided by the UICC, the icon indicated in the command may be used by the terminal to inform the user, in addition to, or instead of the alpha identifier, as indicated with the icon qualifier (see clause 6.5.4);
- if the alpha identifier is provided by the UICC and is a null data object (i.e. length = '00' and no value part), the terminal should not give any information to the user;
- if the alpha identifier is not provided by the UICC, the terminal may give information to the user concerning what is happening.

If the terminal is required to generate a supervisory tone due to the progress of the current call (e.g. the network sends the terminal call control cause information) as defined in TS 122 001 [2], then the call supervisory tone shall take precedence over the tone requested by the UICC.

6.4.6 POLL INTERVAL

This procedure negotiates how often the terminal shall send STATUS commands related to Proactive Polling (defined in TS 102 221 [1] and in TS 151 011 [8]). The UICC indicates the poll interval it requests from then onwards, and the terminal responds through TERMINAL RESPONSE with the maximum interval that it will use. If the terminal does not support the poll interval requested by the UICC, then the terminal shall respond with the closest interval to the one requested by the UICC, or, if the intervals the terminal can offer are equidistant (higher and lower) from the UICC's request, the terminal shall respond with the lower interval of the two.

Applications on the UICC should not request short time intervals for an extended period, as this will have an adverse effect on battery life, and should not use this command for time management purposes.

6.4.7 REFRESH

The purpose of this command is to enable the terminal to be notified of the changes to the UICC configuration that have occurred as the result of a NAA application activity. It is up to the NAA application to ensure that this is done correctly.

On a 3G platform, the UICC may indicate the AID of the NAA application it wants to REFRESH:

- if the indicated NAA is active, the terminal shall perform the REFRESH;
- if indicated NAA is not active, the terminal shall send a TERMINAL RESPONSE. The terminal shall not select the indicated NAA;
- if no AID is indicated, then the terminal shall assume the REFRESH applies to the current NAA application.

A 2G platform shall not provide the AID Simple-TLV.

The command supports seven different modes:

- NAA Initialization. This mode tells the terminal to carry out NAA initialization as it is defined by the NAA, starting after the PIN verification procedure;

- NAA File Change Notification. This mode advises the terminal of the identity of the EFs that have been changed (in structure and/or contents) in the indicated NAA and files under DF_{TELECOM}. This information can be used by the terminal if there is an image of NAA EFs in the terminal's memory, to determine whether it needs to update this image;
- NAA Initialization and File Change Notification. This is a combination of the first two modes above;
- NAA Initialization and Full File Change Notification. This mode causes the terminal to perform the NAA initialization procedure of the first mode above and advises the terminal that several EFs have been changed (in structure or contents) in the indicated NAA. If there is an image of NAA EFs in the terminal's memory, the terminal shall completely update this image;
- UICC Reset. This mode causes the terminal to run the UICC session termination procedure in accordance with TS 102 221 [1]. Subsequently, the terminal performs a reset (warm reset preferred) on the UICC and starts a new application session. The terminal shall not send the TERMINAL RESPONSE; this is an exception from the normal procedure, where TERMINAL RESPONSE is sent after completion of the command. The UICC shall interpret the reset as an implicit TERMINAL RESPONSE. The UICC Reset mode is used when a CAT requires ATR or complete UICC initialization procedures to be performed;
- NAA Application Reset. This mode causes the terminal to run the NAA session termination and the NAA application closure procedures in accordance with NAA specification. Subsequently, the terminal performs NAA initialization procedure. This mode is only applicable on a 3G platform, and shall not be used on a 2G platform;
- NAA Session Reset. This mode is equivalent to "NAA Initialization and File Change Notification" mode and in addition requires the terminal to perform a specific NAA procedure. This mode is only applicable on a 3G platform, and shall not be used on a 2G platform.

If the terminal performs the REFRESH command successfully for only those EFs indicated in the mode, the terminal shall inform the UICC using TERMINAL RESPONSE (OK), after it has completed its refreshing (i.e. taking into account the new value of the EFs).

For REFRESH commands with mode other than "UICC Reset" or "NAA Application Reset", it is permissible for the terminal, as part of its execution of the REFRESH command, to read EFs in addition to those notified by the UICC, or to perform a NAA initialization, provided that the procedure executed wholly encompasses the mode requested by the UICC and does not involve re-entering the PIN. The terminal shall not electrically reset the UICC. If the terminal does the refreshing successfully, it shall inform the UICC using TERMINAL RESPONSE (Refresh performed with additional EFs read), after the terminal has completed its refreshing. It should be noted that reading additional EFs will lengthen the refresh procedure.

If the terminal receives a REFRESH command while in a state where execution of the command would be unacceptable, upsetting the current user operation (e.g. notification during a call that the IMSI has changed), the terminal shall inform the UICC using TERMINAL RESPONSE (terminal currently unable to process command - currently busy on call) or TERMINAL RESPONSE (terminal currently unable to process command - screen is busy) as appropriate.

NOTE: Many MEs copy an image of the NAA application files to the terminal at initialization to speed up access to these fields during a NAA session. One of the purposes of this coding of the REFRESH command is to enable MEs to change such an image efficiently.

If, on receipt of the REFRESH command, the terminal replies that it is busy (e.g. in call or navigating menus), the toolkit application may retry it later.

It is recommended for the terminal to minimize the use of sending temporary problem TERMINAL RESPONSE, as during the period between the UICC issuing a REFRESH command and the terminal performing the refresh procedure, there may be inconsistencies between data held in the terminal and in the UICC. However, responsibility for retrying of all pro-active commands lies with the UICC.

6.4.8 SET UP MENU

The UICC shall supply a set of menu items, which shall be integrated with the menu system (or other MMI facility) in order to give the user the opportunity to choose one of these menu items at his own discretion. Each item comprises a short identifier (used to indicate the selection), a text string and optionally an icon identifier, contained in an item icon identifier list data object located at the end of the list of items.

The UICC shall include an alpha identifier, and optionally an icon identifier, which acts as a title for the list of menu items. This icon may be used by the terminal to provide an entry into the list of toolkit menu items for the user.

If an icon is provided by the UICC, the icon(s) indicated in the command may be used by the terminal in addition to, or instead of the alpha identifier or text string, as indicated with the icon qualifier (see clause 6.5.4). Additionally if soft key preferred is indicated in the command details and soft key for SET UP MENU is supported by the terminal and the number of icons items does not exceed the number of soft keys available then the terminal shall display those icons as soft key.

The UICC may include an items next action indicator data object located at the end of the list of items. The inclusion of the items next action indicator is to allow the terminal to indicate to the user the consequences of performing the selection of an item.

NOTE: The maximum amount of data sent in one proactive UICC command is 256 bytes. It is therefore unavoidable that there is trade-off between the number of items and the length of the descriptive text (the alpha identifier of the SET-UP MENU command and the text strings of the items), e.g. for an average length of 10 bytes per text string the maximum amount of items is 18.

The list of menu items shall then be part of the menu system of the terminal and the user is allowed to select an item from this list. The presentation style is left as an implementation decision to the terminal manufacturer. However, the terminal shall present the menu items in the order given by the UICC, unless instructed otherwise by the user, or when this would be inappropriate for the presentation style of the terminal. The menu provided by the UICC in the last SET UP MENU command shall no longer be part of the menu system of the terminal if the terminal is powered off or the UICC is removed or electrically reset.

Any subsequent SET-UP MENU command replaces the current list of menu items supplied in the previous SET-UP MENU command. The SET-UP MENU command can also be used to remove a menu from the menu system in the terminal, see clause 6.6.7.

When the terminal has successfully integrated or removed the list of menu items, it shall send TERMINAL RESPONSE (OK) to the UICC.

When the terminal is not able to successfully integrate or remove the list of menu items, it shall sent TERMINAL RESPONSE (Command beyond terminal's capabilities).

When the user has selected one of the menu items of this menu item list, then the terminal shall use the Menu Selection mechanism to transfer the identifier of the selected menu item to the UICC.

If help is available for the command and if the user has indicated the need to get help information on one of the menu items, the terminal shall use the Menu Selection mechanism to inform the UICC about this help request.

6.4.9 SELECT ITEM

The UICC shall supply a set of items from which the user may choose one. Each item comprises a short identifier (used to indicate the selection), a text string and optionally an icon identifier, contained in an item icon identifier list data object located at the end of the list of items.

Optionally the UICC may include an alpha identifier, and an icon identifier. These are intended to act as a title for the list of items. The UICC may include an items next action indicator data object located at the end of the list of items. The inclusion of the items next action indicator is to allow the terminal to indicate to the user the consequences of performing the selection of an item.

The alpha identifier included by the UICC shall be used by the terminal as the title for the list of items.

If an icon is provided by the UICC, the icon(s) indicated in the command may be used by the terminal in addition to, or instead of the alpha identifier, as indicated with the icon qualifier (see clause 6.5.4). Additionally, if "selection using soft key preferred" is indicated in the command details and "soft key for SELECT ITEM" is supported by the terminal and the number of icons items does not exceed the number of soft keys available, then the terminal shall display those icons as soft keys.

NOTE: The maximum amount of data sent in one proactive UICC command is 256 bytes. It is therefore unavoidable that there is trade-off between the number of items and the length of the descriptive text (the alpha identifier of the SELECT ITEM command and the text strings of the items), e.g. for an average length of 10 bytes per text string the maximum amount of items is 18.

The terminal shall present the list of text strings to the user, and allow the user to select an item from this list. A flag of the command qualifier (see clause 8.6) indicates whether the list is a choice of navigation options, or a choice of data values. The presentation style is left as an implementation decision to the terminal manufacturer. However, the terminal shall present the menu items in the order given by the UICC, unless instructed otherwise by the user, or when this would be inappropriate for the presentation style of the terminal. The menu provided by the UICC in the last SET UP MENU command shall no longer be part of the menu system of the terminal if the terminal is powered off or the UICC is removed or electrically reset.

The UICC may supply with the list, if applicable, indication of the default item, e.g. the previously selected item.

When the user has selected an item, the terminal shall send TERMINAL RESPONSE (OK) to the UICC with the identifier of the item chosen:

- if the user has indicated the need to end the proactive UICC session, the terminal shall send a TERMINAL RESPONSE with "Proactive UICC session terminated by the user" result value;
- if the user has indicated the need to go backwards in the proactive UICC session, the terminal shall send a TERMINAL RESPONSE with "Backward move in the proactive UICC session requested by the user" result value;
- if the terminal decides that no user response has been received, the terminal shall send a TERMINAL RESPONSE with "No response from user" result value;
- if help information is available for the command and if the user has indicated the need to get help information, the terminal shall send a TERMINAL RESPONSE with "help information required by the user" result value to the UICC with the identifier of the item for which the user is requiring help information.

6.4.10 SEND SHORT MESSAGE

This command requests the terminal to send a short message. The type and coding of TPDU depends on the network technology.

Two types are defined:

- a short message to be sent to the network, where the user data can be passed transparently;
- a short message to be sent to the network where the text needs to be packed by the terminal.

Coding of the message, and use of packing are defined by the appropriate and network technologies dependent specifications.

Optionally, the UICC may include in this command an alpha identifier. The use of this alpha identifier by the terminal is described below:

- if the alpha identifier is provided by the UICC and is not a null data object, the terminal shall use it to inform the user. This is also an indication that the terminal should not give any other information to the user on the fact that the terminal is sending a short message. If an icon is provided by the UICC, the icon indicated in the command may be used by the terminal to inform the user, in addition to, or instead of the alpha identifier, as indicated with the icon qualifier (see clause 6.5.4);
- if the alpha identifier is provided by the UICC and is a null data object (i.e. length = '00' and no value part), this is an indication that the terminal should not give any information to the user on the fact that the terminal is sending a short message;

- if the alpha identifier is not provided by the UICC, the terminal may give information to the user concerning what is happening.

If the terminal is capable of SMS-MO, then it shall send the data as a Short Message TPDU to the destination address. The terminal shall give the result to the UICC using TERMINAL RESPONSE (indicating successful or unsuccessful transmission of the Short Message) after receiving a confirmation of the transfer from the network. If an alpha identifier was provided by the UICC, the terminal should not give any information to the user at the reception of SMS RP-ACK or RP-Error.

If the Short Message TPDU is unsuccessfully received by the network, the terminal shall inform the UICC using TERMINAL RESPONSE (network currently unable to process command). If a null alpha identifier was provided by the UICC, the terminal should not give any information to the user at the unsuccessful network reception.

The destination address and the SMSC address included in the SEND SHORT MESSAGE proactive command shall not be checked against those of the FDN list, even if the Fixed Dialling Number service is enabled

6.4.11 Void

6.4.12 Void

6.4.13 SET UP CALL

This command is issued by the UICC to request a call set up.

Three types are defined:

- set up a call, but only if not currently busy on another call;
- set up a call, putting all other calls (if any) on hold;
- set up a call, disconnecting all other calls (if any) first.

For each of these types, the UICC may request the use of an automatic redial mechanism. The UICC may also request an optional maximum duration for the redial mechanism. The terminal shall attempt at least one call set-up.

In addition to the called party number, the command may contain capability configuration parameters (giving the bearer capability to request for the call) and the called party subaddress. The terminal shall use these in its call set-up request to the network. The command may also include DTMF digits, which the terminal shall send to the network after the call has connected. The terminal shall not locally generate audible DTMF tones and play them to the user.

NOTE: On the downlink audio, DTMF tones reflected by the network may be heard.

It is possible for the UICC to request the terminal to set up an emergency call by supplying the number "112" as called party number. The terminal may translate this number in the appropriate technology specific number or procedure.

The number included in the SET UP CALL proactive command shall not be checked against those of the FDN list, even if the Fixed Dialling Number service is enabled.

Upon receiving this command, the terminal shall decide if it is able to execute the command. Examples are given below, but the list is not exhaustive:

- if the command is rejected because the terminal is busy on another call, the terminal informs the UICC using TERMINAL RESPONSE (terminal unable to process command - currently busy on call).

If the terminal is able to set up the call on the serving network, the terminal shall:

- alert the user (as for an incoming call). This is the confirmation phase;
- optionally, the UICC may include in this command one or two alpha-identifiers. The use of these alpha-identifiers by the terminal is described below:
 - if the first alpha identifier is provided by the UICC and is not a null data object, the terminal shall use it during the user confirmation phase. This is also an indication that the terminal should not give any other information to the user during the user confirmation phase. If an icon is provided by the UICC, the icon indicated in the command may be used by the terminal to inform the user, in addition to, or instead of the alpha identifier, as indicated with the icon qualifier (see clause 6.5.4);
 - if the first alpha identifier is not provided by the UICC or is a null data object (i.e. length = '00' and no value part), the terminal may give information to the user;
 - if the second alpha identifier (i.e. the one after the mandatory address object) is provided by the UICC and is not a null data object, the terminal shall use it during the call set-up phase and during the call. If an icon is provided by the UICC, the icon indicated in the command may be used by the terminal to inform the user, in addition to, or instead of the alpha identifier, as indicated with the icon qualifier (see clause 6.5.4);
 - if the second alpha identifier is not provided by the UICC or is a null data object (i.e. length = '00' and no value part), the terminal may give information to the user;
- if the user accepts the call, the terminal shall then set up a call to the destination address given in the response data, with the relevant capability configuration parameters and called party subaddress (if provided by the UICC);
- if the user does not accept the call, or rejects the call, then the terminal informs the UICC using TERMINAL RESPONSE (user did not accept the proactive command). The operation is aborted;
- if the user has indicated the need to end the proactive UICC session, the terminal shall send a TERMINAL RESPONSE with "Proactive UICC session terminated by the user" result value;
- optionally, during call set-up, the terminal can give some audible or display indication concerning what is happening;
- once a CONNECT message has been received from the network (defined in TS 124 008 [20]), the terminal shall inform the UICC that the command has been successfully executed, using TERMINAL RESPONSE. Operation of the call then proceeds as normal.

If the first call set-up attempt is unsuccessful:

- if the UICC did not request redial then the terminal shall inform the UICC using TERMINAL RESPONSE (network currently unable to process command), and not redial to set-up the call;
- if the UICC requested redial, then the terminal may automatically redial the call (depending on its capability/configuration). In this case, the terminal shall not send a command result to the UICC concerning the first or any subsequent failed set-up attempts. If the call set-up has not been successful, and the terminal is not going to perform any more redials, or the time elapsed since the first call set-up attempt has exceeded the duration requested by the UICC, then the terminal shall inform the UICC using TERMINAL RESPONSE (network currently unable to process command), and the redial mechanism shall be terminated;
- if the user stops the call set-up attempt or the redial mechanism before a result is received from the network, the terminal informs the UICC using TERMINAL RESPONSE (user cleared down call before connection or network release).

If the terminal supports the Last Number Dialed service, the terminal shall not store in EF_{LND} the call set-up details (called party number and associated parameters) sent by the UICC in this command.

6.4.14 POLLING OFF

This command disables the Proactive Polling (defined in TS 102 221 [1] and in TS 151 011 [8]). UICC Presence Detection (defined in TS 102 221 [1]) or SIM presence detection (defined in TS 151 011 [8]) are not affected by this command.

6.4.15 PROVIDE LOCAL INFORMATION

This command requests the terminal to send current local information to the UICC. At present, this information is restricted to:

- location information;
- the terminal identity (e.g. IMEI, ESN) of the terminal;
- the network measurement results;
- the current date, time and time zone;
- the current terminal language setting;
- the timing advance (access network dependent);
- the current access technology.

The terminal shall return the requested local information within a TERMINAL RESPONSE. The terminal shall return the current date and time as set by the user. If available, the terminal shall also return the time zone known from the network. If the time zone information is not available, the terminal shall return 'FF' for this element.

If language setting is requested, the terminal shall return the currently used language.

If the access technology is requested, the terminal shall return the current access technology that the terminal is using.

6.4.16 SET UP EVENT LIST

The UICC shall use this command to supply a set of events. This set of events shall become the current list of events for which the terminal is to monitor.

Any subsequent SET UP EVENT LIST command replaces the current list of events supplied in the previous SET UP EVENT LIST command. The SET UP EVENT LIST command can also be used to remove the entire list of events current in the terminal; see clause 6.6.16. The list of events provided by the UICC in the last SET UP EVENT LIST command shall be removed if the terminal is powered off or the UICC is removed or electrically reset.

When the terminal has successfully accepted or removed the list of events, it shall send TERMINAL RESPONSE (OK) to the UICC.

When the terminal is not able to successfully accept or remove the list of events, it shall send TERMINAL RESPONSE (Command beyond terminal's capabilities).

When one of the events in the current list occurs, then the terminal shall use the Event Download mechanism to transfer details of the event to the UICC, see clause 7.5.

6.4.17 PERFORM CARD APDU

This clause applies if class "a" is supported.

This command requests the terminal to send an APDU command to the additional card (Card x).

The command includes:

- the additional card reader identifier, which is part of the Device Identities object;
- the APDU command to be performed.

Upon receiving this command, the terminal shall decide if it is able to execute the command:

- if the command is rejected because the card reader identity is not valid, the terminal informs the UICC using TERMINAL RESPONSE (MultipleCard command error - Card reader not valid);
- if the command is rejected because the card reader is not present or has been removed, the terminal informs the UICC using TERMINAL RESPONSE (MultipleCard command error - Card reader removed or not present);
- if the command is rejected because the card is not present or has been removed, the terminal informs the UICC using TERMINAL RESPONSE (MultipleCard command error - Card removed or not present);
- if the command is rejected because the card reader is busy, the terminal informs the UICC using TERMINAL RESPONSE (MultipleCard command error - Card reader busy);
- if the command is rejected because the card is not powered on, the terminal informs the UICC using TERMINAL RESPONSE (MultipleCard command error - Card powered off);
- if the command is rejected because the received C-APDU format is not valid, the terminal informs the UICC using TERMINAL RESPONSE (MultipleCard command error - C-APDU format error).

If the terminal is able to transfer the C-APDU to the addressed card, the terminal shall:

- transfer the C-APDU to the addressed card, through the selected terminal - Card x protocol;
- extract the R-APDU data from the addressed card if so requested by the UICC;
- if the command fails because no response is received from Card x, inform the UICC using TERMINAL RESPONSE (MultipleCard command error - Card mute);
- if the command fails because of any form of transmission error, inform the UICC using TERMINAL RESPONSE (MultipleCard command error - Transmission error);
- if the command fails because the terminal does not support the protocol used by Card x, inform the UICC using TERMINAL RESPONSE (MultipleCard command error - Protocol not supported);
- if the command is performed successfully from a protocol point of view, include the R-APDU within the TERMINAL RESPONSE command.

6.4.18 POWER OFF CARD

This clause applies if class "a" is supported.

This command requests the terminal to close a session with the additional card (Card x).

The command includes the additional card reader identifier, which is part of the Device Identities object.

Upon receiving this command, the terminal shall decide if it is able to execute the command:

- if the command is rejected because the card reader identity is not valid, the terminal informs the UICC using TERMINAL RESPONSE (MultipleCard command error - Card reader not valid);
- if the command is rejected because the card reader is not present or has been removed, the terminal informs the UICC using TERMINAL RESPONSE (MultipleCard command error - Card reader removed or not present);
- if the command is rejected because the card is not present or has been removed, the terminal informs the UICC using TERMINAL RESPONSE (MultipleCard command error - Card removed or not present);
- if the command is rejected because the card reader is busy, the terminal informs the UICC using TERMINAL RESPONSE (MultipleCard command error - Card reader busy);

If the terminal is able to execute the command, the addressed Card x shall be deactivated according to ISO/IEC 7816-3 [13].

6.4.19 POWER ON CARD

This clause applies if class "a" is supported.

This command requests the terminal to start a session with the additional card (Card x).

The command includes the additional card reader identifier, which is part of the Device Identities object.

Upon receiving this command, the terminal shall decide if it is able to execute the command:

- if the command is rejected because the card reader identity is not valid, the terminal informs the UICC using TERMINAL RESPONSE (MultipleCard command error - Card reader not valid);
- if the command is rejected because the card reader is not present or has been removed, the terminal informs the UICC using TERMINAL RESPONSE (MultipleCard command error - Card reader removed or not present);
- if the command is rejected because the card is not present or has been removed, the terminal informs the UICC using TERMINAL RESPONSE (MultipleCard command error - Card removed or not present);
- if the command is rejected because the card reader is busy, the terminal informs the UICC using TERMINAL RESPONSE (MultipleCard command error - Card reader busy).

If the terminal is able to execute the command, and the addressed Card x is powered off, the terminal shall activate the addressed Card x according to ISO/IEC 7816-3 [13]. If the addressed Card x is already powered on, the terminal shall treat the POWER ON CARD command as a warm reset, as defined in ISO/IEC 7816-3 [13].

The terminal shall return the Answer To Reset within the TERMINAL RESPONSE command. If no ATR is received, the terminal shall inform the UICC using TERMINAL RESPONSE (MultipleCard command error - Card mute).

Application writers are advised that the Card x should not be powered up for longer than necessary due to battery life considerations.

6.4.20 GET READER STATUS

This clause applies if class "a" is supported.

This command requests the terminal to get information about all interfaces or the indicated interface to additional card reader(s). This information is restricted to:

- card reader status;
- card reader identifier.

The terminal shall return the requested information from the interfaces to additional card reader(s) within a TERMINAL RESPONSE command.

6.4.21 TIMER MANAGEMENT

This command requests the terminal to manage timers running physically in the terminal. The possible actions on timers are defined below:

- start a timer;
- deactivate a timer;
- get the current value of a timer.

The UICC and the terminal are able to manage eight different timers running in parallel. The possible duration of a timer is between 1 second and 24 hours. The resolution of a timer is 1 second. The precision of the returned value cannot be relied upon in all cases due to potential terminal activities. When the terminal is switched off or the UICC is reset, all timers are deactivated in the terminal.

For a given timer:

- when the UICC requests the terminal to start the timer with a duration, then:
 - the terminal shall start the timer with the duration given by the UICC, even if this timer is already running. When a timer is started, it takes the value given by the UICC, and is then decremented. The terminal shall inform the UICC that the command has been successfully executed, using **TERMINAL RESPONSE (OK)**.
- when the UICC requests the terminal to deactivate the timer, then:
 - if the timer is running, the terminal shall deactivate the timer. This prevents the UICC from receiving unnecessary information at the expiration of a timer. The terminal shall pass the current value of the timer (i.e. the duration that remains before the timer elapses) to the UICC, using **TERMINAL RESPONSE**;
 - if the timer is already deactivated, the terminal shall inform the UICC using **TERMINAL RESPONSE ("action in contradiction with the current timer state")**.
- when the UICC requests the terminal to get the current value of the timer, then:
 - if the timer is running, the terminal shall pass the current value of the timer (i.e. the duration that remains before the timer elapses) to the UICC, using **TERMINAL RESPONSE**;
 - if the timer is deactivated, the terminal shall inform the UICC using **TERMINAL RESPONSE ("action in contradiction with the current timer state")**.

When a timer expires (i.e. reaches zero), the terminal shall use the Timer Expiration mechanism to transfer the identifier of the timer that has expired and the difference between the time when this transfer occurs and the time when the timer was initially started. The terminal shall then deactivate the timer.

6.4.22 SET UP IDLE MODE TEXT

The UICC shall supply a text string, which shall be displayed by the terminal as an idle mode text if the terminal is able to do it. The presentation style is left as an implementation decision to the terminal manufacturer. The idle mode text shall be displayed in a manner that ensures that neither the network name nor the service providers name are affected.

If idle mode text is competing with other information to be displayed on the same area, for instance a CB message, the idle mode text shall be replaced by the other information. It is up to the terminal to restore the idle mode text when the other information has no longer to be displayed.

The text shall be removed from the terminal's memory and display if either:

- the terminal is powered off; or
- the UICC is removed or electrically reset; or
- a **REFRESH** command occurs with "initialization" or "reset".

Any subsequent **SET UP IDLE MODE TEXT** command replaces the current idle mode text of the previous **SET UP IDLE MODE TEXT**. The **SET UP IDLE MODE TEXT** command can also be used to remove an idle mode text from the terminal, see clause 6.6.22.

When the terminal has successfully integrated or removed an idle mode text, it shall send **TERMINAL RESPONSE (OK)** to the UICC.

When the terminal is not able to successfully integrate or remove the idle mode text, it shall send **TERMINAL RESPONSE "Command beyond terminal's capabilities"** to the UICC.

6.4.23 RUN AT COMMAND

This clause applies if class "b" is supported by the terminal and enabled by the subscriber through the terminal.

If this feature is enabled, the UICC uses this command to send an AT Command to the terminal as though initiated by an attached TE. The terminal shall then return an AT Response within a TERMINAL RESPONSE to the UICC.

If this feature is disabled in the card or in the terminal, or the terminal does not support the RUN AT COMMAND, then if the CAT receives an instruction from the network to issue the command, the CAT should return an error to the network.

Optionally, the UICC may include in this command an alpha identifier. The use of this alpha identifier by the terminal is described below:

- if the alpha identifier is provided by the UICC and is not a null data object, the terminal shall use it to inform the user. This is also an indication that the terminal should not give any other information to the user on the fact that the terminal is performing an AT command. If an icon is provided by the UICC, the icon indicated in the command may be used by the terminal to inform the user, in addition to, or instead of the alpha identifier, as indicated with the icon qualifier (see clause 6.5.4);
- if the alpha identifier is provided by the UICC and is a null data object (i.e. length = '00' and no value part), this is an indication that the terminal should not give any information to the user on the fact that the terminal is performing an AT command;
- if the alpha identifier is not provided by the UICC, the terminal may give information to the user concerning what is happening.

6.4.24 SEND DTMF

This command requests the terminal to send a DTMF string after a call has been successfully established either by the proactive command SET UP CALL or the user. This command is independent of sending DTMF within the call set up (as defined in the SET UP CALL command) and therefore, can be used at any time during a call.

The terminal shall not locally generate audible DTMF tones and play them to the user.

NOTE: On the downlink audio, DTMF tones reflected by the network may be heard.

It shall be possible for the user to deactivate this command.

The sending of a DTMF string applies only to the currently active call.

The TERMINAL RESPONSE indicating that the command has been performed successfully shall be sent after the complete DTMF string has been sent to the network by the terminal.

If the command is sent in idle mode, or a call is terminated or put on hold before the complete DTMF string has been sent to the network, the terminal shall inform the UICC using TERMINAL RESPONSE '20' with the additional information "Not in speech call".

If the user indicates the need to end the proactive UICC application session whilst the terminal is sending the DTMF string, the terminal shall stop sending the DTMF string and shall send a TERMINAL RESPONSE with "Proactive UICC application session terminated by the user" result value.

Optionally, the UICC may include in this command an alpha identifier. The use of this alpha identifier by the terminal is described below:

- if the alpha identifier is provided by the UICC and is not a null data object, the terminal shall use it to inform the user. This is also an indication that the terminal should not give any other information to the user on the fact that the terminal is performing a SEND DTMF command. If an icon is provided by the UICC, the icon indicated in the command may be used by the terminal to inform the user, in addition to, or instead of the alpha identifier, as indicated with the icon qualifier (see clause 6.5.4);
- if the alpha identifier is provided by the UICC and is a null data object (i.e. length = '00' and no value part), this is an indication that the terminal should not give any information to the user on the fact that the terminal is performing a SEND DTMF command;

- if the alpha identifier is not provided by the UICC, the terminal may give information to the user concerning what is happening.

6.4.25 LANGUAGE NOTIFICATION

The UICC shall use this command to notify the terminal about the language currently used for any text string within proactive commands or envelope command responses.

The notified language stays valid within the terminal until the end of the card session or upon executing another LANGUAGE NOTIFICATION command.

When the CAT application is not aware of the current CAT application language, no specific language is in use or several languages are in use, the UICC may notify non-specific language. This has the effect of cancelling a previous specific LANGUAGE NOTIFICATION.

Two types of language notification are defined:

- specific, where an additional Language object shall be included by the UICC;
- non-specific, where no Language object shall be included by the UICC.

Regardless of whether the terminal recognizes the notified language or not, the terminal shall send TERMINAL RESPONSE (OK) to the UICC.

The terminal may use the language included in LANGUAGE NOTIFICATION as appropriate. For instance, this could be done to avoid a mix of languages in screen displays combining terminal MMI and CAT originating text strings.

6.4.26 LAUNCH BROWSER

This command is used to request a browser inside a browser-enabled terminal to interpret the content corresponding to a URL.

Upon receiving this command, the terminal shall decide if it is able to execute the command. Examples are given below, but the list is not exhaustive:

- if the command is rejected because the browser on the terminal is busy or not available, the terminal informs the UICC using TERMINAL RESPONSE (terminal unable to process command - browser unavailable);
- if the command is rejected because the bearer provided in the command is not available, the terminal informs the UICC using TERMINAL RESPONSE (terminal unable to process command - bearer unavailable).

If the terminal is able to execute the command:

- the terminal shall inform the UICC that the command has been successfully taken into account, using TERMINAL RESPONSE;
- the UICC shall end the proactive session;
- then the terminal shall request content using the URL.

If the gateway addresses and/or the bearer objects are present in the command and are non null data objects, then the browser shall use these data to request content using the URL. If the gateway addresses, bearer objects, Provisioning File Reference, Browser Identity or URL are null objects or missing, then the terminal shall use default values (for an example, see reference in annex J).

The terminal shall ask the user for confirmation using the Alpha Identifier/Icon Identifier (user confirmation phase) if present, when it receives a LAUNCH BROWSER command which requests the existing browser session connected to a new URL or to terminate a browser session.

The way the terminal requests content using the URL is outside the scope of the present document (for an example, see reference in annex J).

NOTE: That there is a maximum size for the URL that can be given in argument of this proactive command.

6.4.27 OPEN CHANNEL

6.4.27.1 OPEN CHANNEL related to CS bearer

This clause applies if class "e" is supported.

Upon receiving this command, the terminal shall decide if it is able to execute the command. The UICC shall indicate whether the terminal should establish the link immediately or upon receiving the first transmitted data (on demand).

The UICC provides to the terminal a list of parameters necessary to establish a link.

The UICC may request the use of an automatic reconnection mechanism. The UICC may also request an optional maximum duration for the reconnection mechanism. The terminal shall attempt at least one link establishment set-up.

The UICC may also request an optional maximum duration for the terminal to automatically release the link if no data is exchanged.

If the Fixed Dialling Number service is enabled, the address included in the OPEN CHANNEL proactive command shall not be checked against those of the FDN list.

Upon receiving this command, the terminal shall decide if it is able to execute the command. Examples are given below, but the list is not exhaustive:

- if immediate link establishment is requested and the terminal is unable to set-up a channel using the exact parameters provided by the UICC, the terminal sets up the channel using the best parameters it can support and informs the UICC of the channel identifier and the modified parameters using TERMINAL RESPONSE (Command performed with modification);
- if immediate link establishment is requested and the terminal is unable to set-up the link with the network using the exact parameters provided by the UICC, the terminal informs the UICC using TERMINAL RESPONSE (Network currently unable to process command). The operation is aborted;
- if on demand link establishment is requested and the terminal is unable to set-up a channel using the exact parameters provided by the UICC, the terminal sets up the channel using the best parameters it can support and informs the UICC of the channel identifier and the modified parameters using TERMINAL RESPONSE (Command performed with modification);
- if the command is rejected because the terminal has no channel left with the requested bearer capabilities, the terminal informs the UICC using TERMINAL RESPONSE (Bearer independent protocol error). The operation is aborted;
- if the user does not accept the channel set-up, the terminal informs the UICC using TERMINAL RESPONSE (User did not accept the proactive command). The operation is aborted;
- if the user has indicated the need to end the proactive UICC session, the terminal informs the UICC using TERMINAL RESPONSE (Proactive UICC session terminated by the user). The operation is aborted;
- if the command is rejected because the terminal is busy on another call, the terminal informs the UICC using TERMINAL RESPONSE (terminal unable to process command - currently busy on call). The operation is aborted.

The terminal shall inform the UICC that the command has been successfully executed using TERMINAL RESPONSE:

- if immediate link establishment is requested, the terminal allocates buffers, sets up the link and informs the UICC and reports the channel identifier using TERMINAL RESPONSE (Command performed successfully);
- if on demand link establishment is requested, the terminal allocates buffers, informs the UICC and reports the channel identifier using TERMINAL RESPONSE (Command performed successfully).

If the terminal is able to set up the channel on the serving network, the terminal shall:

- alert the user (as for an incoming call). This is the confirmation phase;

- optionally, the UICC may include in this command an alpha-identifier. The use of this alpha-identifier by the terminal is described below:
 - if the alpha identifier is provided by the UICC and is not a null data object, the terminal shall use it during the user confirmation phase. This is also an indication that the terminal should not give any other information to the user during the user confirmation phase. If an icon is provided by the UICC, the icon indicated in the command may be used by the terminal to inform the user, in addition to, or instead of the alpha identifier, as indicated with the icon qualifier (see clause 6.5.4);
 - if the alpha identifier is not provided by the UICC or is a null data object (i.e. length = '00' and no value part), the terminal may give information to the user;
- if the user accepts the channel, the terminal shall then set up a channel;
- if the user does not accept the channel or rejects the channel, then the terminal informs the UICC using TERMINAL RESPONSE (user did not accept the proactive command). The operation is aborted;
- if the user has indicated the need to end the proactive UICC session, the terminal shall send a TERMINAL RESPONSE with (Proactive UICC session terminated by the user) result value;
- optionally, during call set-up, the terminal can give some audible or display indication concerning what is happening;

If the first link set-up attempt is unsuccessful;

- if the UICC did not request link re-connection then the terminal shall inform the UICC using TERMINAL RESPONSE (network currently unable to process command), and not retry to set-up the link:
 - if the UICC requested link re-connection, then the terminal may automatically retry to set-up the link (depending on its configuration capabilities). In this case, the terminal shall not send a command result to the UICC concerning the first or any subsequent failed set-up attempts. If the link set-up has not been successful, and the terminal is not going to perform any more re-tries, or the time elapsed since the first link set-up attempt has exceeded the duration requested by the UICC, then the terminal shall inform the UICC using TERMINAL RESPONSE (network currently unable to process command), and the re-try mechanism shall be terminated;
 - if the user stops the link set-up attempt or the re-try mechanism before a result is received from the network, the terminal informs the UICC using TERMINAL RESPONSE (user cleared down call before connection or network release).

If the terminal supports the Last Number Dialed service, the terminal shall not store in EF_{LND} the channel set-up details (called party number and associated parameters) sent by the UICC in this command.

6.4.27.2 OPEN CHANNEL related to packet data service bearer

This clause applies if class "e" is supported.

Upon receiving this command, the terminal shall decide if it is able to execute the command. The UICC shall indicate whether the terminal should establish the link immediately or upon receiving the first transmitted data (on demand).

The UICC provides to the terminal a list of parameters necessary to activate a packet data service.

The terminal shall attempt at least one packet data service activation.

Upon receiving this command, the terminal shall decide if it is able to execute the command. Examples are given below, but the list is not exhaustive:

- if immediate packet data service activation is requested and the terminal is unable to set-up a channel using the exact parameters provided by the UICC, the terminal sets up the channel using the best parameters it can support and informs the UICC of the channel identifier and the modified parameters using TERMINAL RESPONSE (Command performed with modification);

- if immediate packet data service activation is requested and the terminal is unable to activate the packet data service with the network using the exact parameters provided by the UICC, the terminal informs the UICC using TERMINAL RESPONSE (Network currently unable to process command). The operation is aborted;
- if on demand link establishment is requested and the terminal is unable to set-up a channel using the exact parameters provided by the UICC, the terminal sets up the channel using the best parameters it can support and informs the UICC of the channel identifier and the modified parameters using TERMINAL RESPONSE (Command performed with modification);
- if the command is rejected because the terminal has no channel left with the requested bearer capabilities, the terminal informs the UICC using TERMINAL RESPONSE (Bearer independent protocol error). The operation is aborted;
- if the user does not accept the channel set-up, the terminal informs the UICC using TERMINAL RESPONSE (User did not accept the proactive command). The operation is aborted;
- if the user has indicated the need to end the proactive UICC session, the terminal informs the UICC using TERMINAL RESPONSE (Proactive UICC session terminated by the user). The operation is aborted;
- if the command is rejected because the class B terminal is busy on a call, the terminal informs the UICC using TERMINAL RESPONSE (terminal unable to process command - currently busy on call). The operation is aborted.

The terminal shall inform the UICC that the command has been successfully executed using TERMINAL RESPONSE:

- if immediate Packet data service activation is requested, the terminal allocates buffers, activates the packet data service and informs the UICC and reports the channel identifier using TERMINAL RESPONSE (Command performed successfully);
- if on demand packet data service activation is requested, the terminal allocates buffers, informs the UICC and reports the channel identifier using TERMINAL RESPONSE (Command performed successfully).

If the terminal is able to set up the channel on the serving network, the terminal shall:

- alert the user (as for an incoming call). This is the confirmation phase;
- optionally, the UICC may include in this command an alpha-identifier. The use of this alpha-identifier by the terminal is described below:
 - if the alpha identifier is provided by the UICC and is not a null data object, the terminal shall use it during the user confirmation phase. This is also an indication that the terminal should not give any other information to the user during the user confirmation phase. If an icon is provided by the UICC, the icon indicated in the command may be used by the terminal to inform the user, in addition to, or instead of the alpha identifier, as indicated with the icon qualifier (see clause 6.5.4);
 - if the alpha identifier is not provided by the UICC or is a null data object (i.e. length = '00' and no value part), the terminal may give information to the user;
- if the user accepts the channel, the terminal shall then set up a channel;
- if the user does not accept the channel or rejects the channel, then the terminal informs the UICC using TERMINAL RESPONSE (user did not accept the proactive command). The operation is aborted;
- if the user has indicated the need to end the proactive UICC session, the terminal shall send a TERMINAL RESPONSE with (Proactive UICC session terminated by the user) result value;
- optionally, during packet data service activation, the terminal can give some audible or display indication concerning what is happening;
- if the user stops the packet data service activation attempt before a result is received from the network, the terminal informs the UICC using TERMINAL RESPONSE (user cleared down call before connection or network release).

6.4.27.3 OPEN CHANNEL related to local bearer

This clause applies if classes "e" and "f" are supported.

This command is used to establish a connection using a local bearer (Bluetooth, IrDA, RS232, USB). The UICC can act as a server or a client. In the server use case, the UICC performs an OPEN CHANNEL only after having received a Local Connection event from the terminal.

Upon receiving this command, the ME shall decide if it is able to execute the command. The UICC shall indicate whether the ME should establish the link immediately or upon receiving the first transmitted data (on demand).

The UICC provides to the terminal a list of parameters necessary to establish a link.

The UICC may request the use of an automatic reconnection mechanism. The UICC may also request an optional maximum duration for the reconnection mechanism. The terminal shall attempt at least one link establishment set-up.

The UICC may also request an optional maximum duration for the terminal to automatically release the link if no data is exchanged.

Upon receiving this command, the terminal shall decide if it is able to execute the command. Examples are given below, but the list is not exhaustive:

- if immediate link establishment is requested and the terminal is unable to set-up a channel using the exact parameters provided by the UICC, the terminal sets up the channel using the best parameters it can support and informs the UICC of the channel identifier and the modified parameters using TERMINAL RESPONSE (Command performed with modification);
- if immediate link establishment is requested and the terminal is unable to set-up the link with the network using the exact parameters provided by the UICC, the terminal informs the UICC using TERMINAL RESPONSE (Network currently unable to process command). The operation is aborted;
- if on demand link establishment is requested and the terminal is unable to set-up a channel using the exact parameters provided by the UICC, the terminal sets up the channel using the best parameters it can support and informs the UICC of the channel identifier and the modified parameters using TERMINAL RESPONSE (Command performed with modification);
- if the command is rejected because the terminal has no channel left with the requested bearer capabilities, the terminal informs the UICC using TERMINAL RESPONSE (Bearer independent protocol error). The operation is aborted;
- if the user does not accept the channel set-up, the terminal informs the UICC using TERMINAL RESPONSE (User did not accept the proactive command). The operation is aborted;
- if the user has indicated the need to end the proactive UICC session, the terminal informs the UICC using TERMINAL RESPONSE (Proactive UICC session terminated by the user). The operation is aborted;
- if the command is rejected because the terminal is busy on another call, the terminal informs the UICC using TERMINAL RESPONSE (terminal unable to process command - currently busy on call). The operation is aborted.

The terminal shall inform the UICC that the command has been successfully executed using TERMINAL RESPONSE:

- if immediate link establishment is requested, the terminal allocates buffers, sets up the link and informs the UICC and reports the channel identifier using TERMINAL RESPONSE (Command performed successfully);
- if on demand link establishment is requested, the terminal allocates buffers, informs the UICC and reports the channel identifier using TERMINAL RESPONSE (Command performed successfully).

If the terminal is able to set up the channel on the requested local bearer, the terminal shall:

- alert the user (as for an incoming call). This is the confirmation phase;
- optionally, the UICC may include in this command an alpha-identifier. The use of this alpha-identifier by the terminal is described below:

- if the alpha identifier is provided by the UICC and is not a null data object, the terminal shall use it during the user confirmation phase. This is also an indication that the terminal should not give any other information to the user during the user confirmation phase. If an icon is provided by the UICC, the icon indicated in the command may be used by the terminal to inform the user, in addition to, or instead of the alpha identifier, as indicated with the icon qualifier (see clause 6.5.4);
- if the alpha identifier is not provided by the UICC or is a null data object (i.e. length = '00' and no value part), the terminal may give information to the user;
- if the user accepts the channel, the terminal shall then set up a channel;
- if the user does not accept the channel or rejects the channel, then the terminal informs the UICC using TERMINAL RESPONSE (user did not accept the proactive command). The operation is aborted;
- if the user has indicated the need to end the proactive UICC session, the terminal shall send a TERMINAL RESPONSE with (Proactive UICC session terminated by the user) result value;
- optionally, during call set-up, the terminal can give some audible or display indication concerning what is happening;
- if the first link set-up attempt is unsuccessful;
- if the UICC did not request link re-connection then the terminal shall inform the UICC using TERMINAL RESPONSE (network currently unable to process command), and not retry to set-up the link:
 - if the UICC requested link re-connection, then the terminal may automatically retry to set-up the link (depending on its configuration capabilities). In this case, the terminal shall not send a command result to the UICC concerning the first or any subsequent failed set-up attempts. If the link set-up has not been successful, and the terminal is not going to perform any more re-tries, or the time elapsed since the first link set-up attempt has exceeded the duration requested by the UICC, then the terminal shall inform the UICC using TERMINAL RESPONSE (network currently unable to process command), and the re-try mechanism shall be terminated;
 - if the user stops the link set-up attempt or the re-try mechanism before a result is received from the network, the terminal informs the UICC using TERMINAL RESPONSE (user cleared down call before connection or network release).

6.4.28 CLOSE CHANNEL

This clause applies if class "e" is supported.

This command requests the terminal to close the channel corresponding to the Channel identifier.

Upon receiving this command, the terminal shall decide if it is able to execute the command:

- if the command is rejected because the channel identifier is not valid, the terminal informs the UICC using TERMINAL RESPONSE (Bearer independent protocol error);
- if the command is rejected because the requested channel is in error, the terminal informs the UICC using TERMINAL RESPONSE (Bearer independent protocol error).

If the terminal is able to process the command:

- the terminal shall release the data transfer, discard the remaining data and inform the UICC that the command has been successfully executed, using TERMINAL RESPONSE;
- optionally, during CLOSE CHANNEL, the terminal can give some audible or display indication concerning what is happening. In this intention, the UICC may include in this command an alpha-identifier. The use of this alpha-identifier by the terminal is described below:
 - if the alpha identifier is provided by the UICC and is not a null data object, the terminal shall use it to indicate the link closing phase. If an icon is provided by the UICC, the icon indicated in the command may be used by the terminal to inform the user, in addition to, or instead of the alpha identifier, as indicated with the icon qualifier (see clause 6.5.4);

- if the alpha identifier is not provided by the UICC or is a null data object (i.e. length = '00' and no value part), the terminal may give information to the user.

6.4.29 RECEIVE DATA

This clause applies if class "e" is supported.

This command requests the terminal to return data from a dedicated Channel identifier according to the number of bytes specified by the UICC.

Upon receiving this command, the terminal shall return the data available in the Rx buffer corresponding to the Channel identifier. Examples are given below, but the list is not exhaustive.

If the terminal is unable to process the command:

- if the command is rejected because the requested channel is already closed the terminal informs the UICC using TERMINAL RESPONSE (Bearer independent protocol error);
- if the user has indicated the need to end the proactive UICC session, the terminal informs the UICC using TERMINAL RESPONSE (Proactive UICC session terminated by the user).

If the terminal is able to process the command:

- if the requested number of bytes is available in the buffer, the terminal shall inform the UICC that the command has been successfully executed, using TERMINAL RESPONSE and return the requested data and the number of bytes remaining in the channel buffer (or FF if more than the maximum bytes remains);
- if the requested number of bytes is available in the buffer but the whole requested data cannot be included in the TERMINAL RESPONSE because of APDU size limits, the ME shall return the maximum number of bytes possible according to the length of other TLVs. The ME shall inform the SIM that the command has been successfully executed, using TERMINAL RESPONSE and shall indicate the number of bytes remaining in the channel buffer (or FF if more than the maximum bytes remains);
- if the requested number of bytes is not yet available in the buffer, the terminal shall NOT wait for the requested number of bytes to arrive. The terminal shall inform the UICC, using TERMINAL RESPONSE (Command performed with missing information) and returns the data currently available in the channel buffer;
- in the case of packet/datagram transmission, the terminal shall put in the Rx buffer a complete packet SDU and only one at one time. For example, if UDP datagrams are received by the terminal, the latter shall insert only the SDU of each UDP packet received in the Rx buffer. After one SDU has been downloaded by the UICC (using one or several RECEIVE DATA commands), the terminal shall insert the next SDU of UDP datagram, and so on;
- if the alpha identifier is provided by the UICC, the terminal shall use it to inform the user. The terminal may also use it to inform the user during data transfer. If an icon is provided by the UICC, the icon indicated in the command may be used by the terminal to inform the user, in addition to, or instead of the alpha identifier, as indicated with the icon qualifier (see clause 6.5.4).

6.4.30 SEND DATA

This clause applies if class "e" is supported.

This command requests the terminal to send data through a previously set up data channel corresponding to a dedicated Channel identifier. The UICC informs the terminal if the data is:

- to be sent immediately; or
- to be stored in a Tx buffer. Then it is up to the terminal to manage the data sending in order to use the bearer in an optimized way. To send the data stored in a Tx buffer, the terminal shall be notified by a "send data immediately" and it shall consider the data presently and previously concatenated in its Tx buffer as one SDU, and send it in only one PDU. The Tx buffer shall then be emptied before returning the TERMINAL RESPONSE to the UICC and allowing new UICC sending.

Upon receiving this command, the terminal shall either immediately send data or store provided data into the Tx buffer corresponding to the Channel identifier. Examples are given below, but the list is not exhaustive.

If the terminal is unable to process the command:

- if the command is rejected because the requested channel is already closed the terminal informs the UICC using TERMINAL RESPONSE (Bearer Independent Protocol error - channel identifier not valid);
- if the command is rejected because the ME could not establish the link (after OPEN CHANNEL (on demand)) or the link was dropped, the ME informs the UICC using TERMINAL RESPONSE (Bearer Independent Protocol error - channel closed);
- if the command is rejected because the channel is temporarily unavailable the terminal informs the UICC using TERMINAL RESPONSE (terminal currently unable to process command);
- if the requested number of bytes of empty space is not yet available in the buffer the terminal informs the UICC using TERMINAL RESPONSE (Bearer Independent Protocol error);
- if the user has indicated the need to end the proactive UICC session, the terminal informs the UICC using TERMINAL RESPONSE (Proactive UICC session terminated by the user).

If the terminal is able to process the command:

- if the requested number of bytes of empty space is available in the buffer the terminal shall inform the UICC that the command has been successfully executed, using TERMINAL RESPONSE and return the number of bytes of empty space available in the Tx buffer (or FF if more than 255 bytes are available);
- in the case of packet/datagram transmission, the structure of the SDU sent by the UICC to the terminal shall be fully respected while sending to the terminal external interface. The size of the SDU is therefore limited by the size of the packet PDU sent over the terminal external interface. In order to send one complete SDU, the CAT application may fill the Tx buffer with several SEND DATA commands, if necessary. Then the terminal shall send the complete SDU in one packet PDU;
- if the alpha identifier is provided by the UICC, the terminal shall use it to inform the user. The terminal may also use it to inform the user during data transfer. If an icon is provided by the UICC, the icon indicated in the command may be used by the terminal to inform the user, in addition to, or instead of the alpha identifier, as indicated with the icon qualifier (see clause 6.5.4).

6.4.31 GET CHANNEL STATUS

This clause applies if class "e" is supported.

This command requests the terminal to return a Channel status data object for each dedicated Channel identifier.

The terminal shall return the requested information concerning the channel(s) within a TERMINAL RESPONSE command.

6.4.32 SERVICE SEARCH

This clause applies if class "f" is supported.

This command is used to search for the availability of a service in the environment of the terminal.

The UICC may provide a Device Filter. The devices responding to the service search shall then be part of the set given by Device Filter. If the Device Filter parameter is not present, no filter on the type of equipment is done by the terminal.

The UICC provides a Service Search parameter. The devices responding to the service search shall then support the requested service.

Upon receiving this command, the terminal shall decide if it is able to execute the command. Examples are given below, but the list is not exhaustive.

- if the command is rejected because the terminal is busy on a call, the terminal informs the UICC using TERMINAL RESPONSE (terminal unable to process command - terminal currently busy on call);

- if the command is rejected because the bearer provided in the command is not available, the terminal informs the UICC using TERMINAL RESPONSE (terminal unable to process command - bearer unavailable).

If the terminal is able to execute the command:

- the terminal performs the service search, gathers all received responses and informs the UICC using TERMINAL RESPONSE (command performed successfully, Service Availability);
- if the command fails because no device in the radio range supported the requested service, the terminal informs the UICC using TERMINAL RESPONSE (Bearer independent protocol error - Service error);
- if the command fails because there is no device reachable, the terminal informs the UICC using TERMINAL RESPONSE (Bearer independent protocol error - Remote device is not reachable).

6.4.33 GET SERVICE INFORMATION

This clause applies if class "f" is supported.

This proactive command is used to look for the complete service record related to a service. By service record, it is meant all information that allows the UICC to define precisely the service (e.g. protocol stacks).

The UICC provides the Attribute Information parameter which indicates which detailed information is required.

Upon receiving this command, the terminal shall decide if it is able to execute the command. Examples are given below, but the list is not exhaustive.

If the command is rejected because the terminal is busy on a call, the terminal informs the UICC using TERMINAL RESPONSE (terminal unable to process command - terminal currently busy on call).

If the command is rejected because the bearer provided in the command is not available, the terminal informs the UICC using TERMINAL RESPONSE (terminal unable to process command - bearer unavailable).

If the terminal is able to execute the command:

- the terminal performs the search for the service details and informs the UICC using TERMINAL RESPONSE (command performed successfully, Service Record). The Service Record shall then be used as argument of an Open Channel proactive command.

If the command fails because there is no device reachable, the terminal informs the UICC using TERMINAL RESPONSE (Bearer independent protocol error - Remote device is not reachable).

If the CAT application already has all information concerning the service, it may directly try to connect the service performing an OPEN CHANNEL, and bypass the GET SERVICE INFORMATION step.

6.4.34 DECLARE SERVICE

This clause applies if class "f" is supported.

This command allows the UICC to download into the terminal service database the services that the card provides as a server. The declaration is to be made on a service by service basis, at the set up (e.g. after the profile download). The UICC shall indicate whether the terminal is required to add a new service in the terminal service database or to remove a service from the terminal service database.

When adding a new service, the UICC shall provide a Service Record that the terminal is required to register into its local service database.

When removing a service, the UICC shall provide the Service Identifier which uniquely identifies the service to be deleted from the database.

Upon receiving this command, the terminal shall decide if it is able to execute the command. Examples are given below, but the list is not exhaustive.

If the command is rejected because the terminal is busy on a call, the terminal informs the UICC using TERMINAL RESPONSE (terminal unable to process command - terminal currently busy on call).

If the command is rejected because the terminal has not enough memory available to store the service record, the terminal informs the UICC using TERMINAL RESPONSE (Bearer Independent Protocol Error - Requested buffer size not available).

If the command for deletion is rejected because the service identifier is not valid, the terminal informs the UICC using TERMINAL RESPONSE (Bearer Independent Protocol Error - Service identifier unknown).

If the command is performed with modification of certain parameters of the Service Record (of which value is dynamically assigned by the terminal), the terminal informs the UICC using TERMINAL RESPONSE (command performed with modification).

If the terminal is able to execute the command: the terminal shall inform the UICC that the command has been successfully performed using TERMINAL RESPONSE (command performed successfully).

When performing a DECLARE SERVICE for deletion, if the UICC provides a Service Identifier parameter different from 'FF', the terminal shall ignore the parameter and proceed with the command.

Note that a service can be coded using a coding type issued from a specific local bearer technology (e.g. Bluetooth or IrDA); however this service shall be considered by the terminal as available for any bearer.

6.5 Common elements in proactive UICC commands

6.5.1 Command number

The command number is to cater for the future possibility of multiple ongoing commands (i.e. when the UICC issues further commands before receiving the response to the ongoing command). The implications of such multiple ongoing commands have not been elaborated at this stage of the toolkit specification.

Each command issued by a proactive UICC during a card session shall have its own command number. Command numbers may take any hexadecimal value between '01' and 'FE'. The command number is held in the command details data object.

The UICC is responsible for assigning the command number.

The terminal shall keep a record of the status of each command and its command number, until the terminal gives the result of the command to the UICC, using TERMINAL RESPONSE. After this, the terminal may erase all internal records concerning this command. The command number is then free for allocation by the UICC to a new command.

When the terminal is powered off and on, the details of any ongoing command shall be reset. The terminal shall not be expected to know the status of commands issued in a previous card session.

6.5.2 Device identities

This data object gives the devices which are the source and destination for the instruction. Only certain combinations of source and destination devices are allowed for each proactive command. These are given in clause 10.

6.5.3 Alpha identifier

Many of the commands include an alpha identifier data object. The text it contains shall be displayed on screen by the terminal at the same time as the UICC command is performed.

6.5.4 Icon identifiers

Some commands may provide an icon identifier. Icons are intended to enhance the MMI by providing graphical information to the user. The display of icons is optional for the terminal. If icons are provided by the UICC, the related alpha identifier or text string shall be present and not a null string.

The UICC indicates to the terminal whether the icon replaces an alpha identifier or text string, or whether it accompanies it (see clause 8.32).

If both an alpha identifier or text string, and an icon are provided with a proactive command, and both are requested to be displayed, but the terminal is not able to display both together on the screen, then the alpha identifier or text string takes precedence over the icon.

If the UICC provides an icon identifier with a proactive command, then the terminal shall inform the UICC if the icon could not be displayed by sending the general result "Command performed successfully, but requested icon could not be displayed".

If the terminal receives an icon, and either an empty or no alpha identifier/text string is given by the UICC, than the terminal shall reject the command with general result "Command data not understood by terminal".

NOTE: Application designers should be aware that icons provided by the application may not be displayed by the terminal.

6.6 Structure of proactive UICC commands

The general structure of proactive UICC commands using TLV objects is described in annex C.

6.6.1 DISPLAY TEXT

Description	Clause	M/O/C	Min	Length
Proactive UICC command Tag	9.2	M	Y	1
Length (A+B+C+D+E+F)	-	M	Y	1 or 2
Command details	8.6	M	Y	A
Device identities	8.7	M	Y	B
Text string	8.15	M	Y	C
Icon identifier	8.31	O	N	D
Immediate response	8.43	O	N	E
Duration	8.8	O	N	F

- Duration:
 - Contents: the required duration for execution of the command before the timeout expires. Resolution and the precision of the time value are in accordance with clause 6.4.21.

6.6.2 GET INKEY

Description	Clause	M/O/C	Min	Length
Proactive UICC command Tag	9.2	M	Y	1
Length (A+B+C+D+E)	-	M	Y	1 or 2
Command details	8.6	M	Y	A
Device identities	8.7	M	Y	B
Text string	8.15	M	Y	C
Icon identifier	8.31	O	N	D
Duration	8.8	O	N	E

- Text string:
 - Contents: text for the Terminal to display in conjunction with asking the user to respond.
- Duration:
 - Contents: the duration for execution of the command before the timeout expires. Resolution and the precision of the time value are in accordance with clause 6.4.21.

6.6.3 GET INPUT

Description	Clause	M/O/C	Min	Length
Proactive UICC command Tag	9.2	M	Y	1
Length (A+B+C+D+E+F)	-	M	Y	1 or 2
Command details	8.6	M	Y	A
Device identities	8.7	M	Y	B
Text string	8.15	M	Y	C
Response length	8.11	M	Y	D
Default Text	8.23	O	N	E
Icon identifier	8.31	O	N	F

- Text string:
 - Contents: text for the Terminal to display in conjunction with asking the user to respond.
- Response length:
 - Contents: the minimum and maximum acceptable lengths length in characters (see clause 6.4.3) for the response from the user.
- Default Text:
 - Contents: text for the Terminal to display, corresponds to a default text string offered by the UICC.

6.6.4 MORE TIME

Description	Clause	M/O/C	Min	Length
Proactive UICC command Tag	9.2	M	Y	1
Length (A+B)	-	M	Y	1 or 2
Command details	8.6	M	Y	A
Device identities	8.7	M	Y	B

6.6.5 PLAY TONE

Description	Clause	M/O/C	Min	Length
Proactive UICC command Tag	9.2	M	Y	1
Length (A+B+C+D+E+F)	-	M	Y	1 or 2
Command details	8.6	M	Y	A
Device identities	8.7	M	Y	B
Alpha identifier	8.2	O	N	C
Tone	8.16	O	N	D
Duration	8.8	O	N	E
Icon identifier	8.31	O	N	F

- Tone:
 - Contents: the standard supervisory tone or proprietary Terminal tone that the Terminal shall generate, either on its own or on top of the downlink audio path. If no tone is specified, then the Terminal shall default to "general beep".
- Duration:
 - Contents: the length of time for which the Terminal shall generate the tone, if the tone is continuous or repeatable. For single tones, the value of this data object shall be ignored by the Terminal. If no duration is specified, the Terminal shall default to a duration determined by the Terminal manufacturer.

6.6.6 POLL INTERVAL

Description	Clause	M/O/C	Min	Length
Proactive UICC command Tag	9.2	M	Y	1
Length (A+B+C)	-	M	Y	1 or 2
Command details	8.6	M	Y	A
Device identities	8.7	M	Y	B
Duration	8.8	M	Y	C

- Duration:
 - Contents: the maximum interval between two STATUS commands related to Proactive Polling.

6.6.7 SET-UP MENU

Description	Clause	M/O/C	Min	Length
Proactive UICC command Tag	9.2	M	Y	1
Length (A+B+C+D1+D2+... Dn+E+F+G)	-	M	Y	1 or 2
Command details	8.6	M	Y	A
Device identities	8.7	M	Y	B
Alpha identifier	8.2	M	Y	C
Item data object for item 1	8.9	M	Y	D1
Item data object for item 2	8.9	O	N	D2
...	8.9	O	N	Dx
Item data object for last item in list	8.9	O	N	Dn
Items Next Action Indicator	8.24	O	N	E
Icon identifier	8.31	O	N	F
Item Icon identifier list	8.32	O	N	G

The SET-UP MENU command BER-TLV data object shall contain Item SIMPLE-TLV data objects. Each Item data object contains an item in the list, for the user to choose. The length of each Item data object may be different. Within a list, each Item shall have a unique item identifier.

If the "Item data object for item 1" is a null data object (i.e. length = '00' and no value part), this is an indication to the terminal to remove the existing menu from the menu system in the terminal.

If the UICC provides an Items Next Action Indicator data object, the comprehension required flag shall be set to '0'.

The UICC may provide a title icon identifier data object and/or an item icon identifier list data object. The item icon identifier data object contains an icon identifier for each item.

6.6.8 SELECT ITEM

Description	Clause	M/O/C	Min	Length
Proactive UICC command Tag	9.2	M	Y	1
Length (A+B+C+D1+D2+... Dn+E+F+G+H)	-	M	Y	1 or 2
Command details	8.6	M	Y	A
Device identities	8.7	M	Y	B
Alpha identifier	8.2	O	N	C
Item data object for item 1	8.9	M	Y	D1
Item data object for item 2	8.9	O	N	D2
...	8.9	O	N	Dx
Item data object for last item in list	8.9	O	N	Dn
Items Next Action Indicator	8.24	O	N	E
Item Identifier	8.10	O	N	F
Icon identifier	8.31	O	N	G
Item Icon identifier list	8.32	O	N	H

The SELECT ITEM command BER-TLV data object shall contain Item SIMPLE-TLV data objects. Each Item data object contains an item in the list, for the user to choose. The length of each Item data object may be different. Within a list, each Item shall have a unique item identifier. The SELECT ITEM command BER-TLV data object may contain a single Item Identifier data object as an indication of the default item. The Comprehension Required flag in the Item Identifier data object shall be set to 0, indicating that it is not mandatory for the terminal to support indication of the default item.

If the UICC provides an Items Next Action Indicator data object, the comprehension required flag shall be set to '0'.

The UICC may provide a title icon identifier data object and/or an item icon identifier list data object. The item icon identifier data object contains an icon identifier for each item.

6.6.9 SEND SHORT MESSAGE

Description	Clause	M/O/C	Min	Length
Proactive UICC command Tag	9.2	M	Y	1
Length (A+B+C+D+E+F+G)	-	M	Y	1 or 2
Command details	8.6	M	Y	A
Device identities	8.7	M	Y	B
Alpha identifier	8.2	O	N	C
Address	8.1	C	N	D
3GPP-SMS TPDU	8.13	C	Y/N	E
CDMA-SMS TPDU	8.71	C	Y/N	F
Icon identifier	8.31	O	N	G

The address data object may hold the address of the Service Centre for some access technologies. If no address is transferred and an address is needed, then the ME shall insert the default Service Centre address.

Either 3GPP-SMS TPDU or CDMA-SMS TPDU shall be present in the SEND SHORT MESSAGE command. The UICC shall not send the 3GPP-SMS TPDU and the CDMA-SMS TPDU in the same command.

6.6.10 Void

6.6.11 Void

6.6.12 SET UP CALL

Description	Clause	M/O/C	Min	Length
Proactive UICC command Tag	9.2	M	Y	1
Length (A+B+C+D+E+F+G+H+I+J)	-	M	Y	1 or 2
Command details	8.6	M	Y	A
Device identities	8.7	M	Y	B
Alpha identifier (user confirmation phase)	8.2	O	N	C
Address	8.1	M	Y	D
Capability configuration parameters	8.4	O	N	E
Subaddress	8.3	O	N	F
Duration	8.8	O	N	G
Icon identifier (user confirmation phase)	8.31	O	N	H
Alpha identifier (call set up phase)	8.2	O	N	I
Icon identifier (call set up phase)	8.31	O	N	J

If the capability configuration parameters are not present, the terminal shall assume the call is a speech call.

If the subaddress is not present, the terminal shall not provide a called party subaddress to the network.

If the duration is not present, the UICC imposes no restrictions on the terminal of the maximum duration of redials.

6.6.13 REFRESH

Description	Clause	M/O/C	Min	Length
Proactive UICC command Tag	9.2	M	Y	1
Length (A+B+C+D)	-	M	Y	1 or 2
Command details	8.6	M	Y	A
Device identities	8.7	M	Y	B
File List	8.18	C	N	C
AID	8.60	O	N	D

For the refresh modes "File Change Notification", "NAA Initialization and File Change Notification" and "NAA Session Reset", the UICC shall supply a File List data object, indicating which EFs need to be refreshed. For other modes, inclusion of a File List is optional, and the terminal shall ignore it.

If an AID TLV is present, it indicates the NAA which needs to be refreshed. If it is not present, the terminal shall assume the current NAA needs to be refreshed. The AID Simple-TLV can only be present on a 3G platform, it shall not be provided on a 2G platform.

6.6.14 POLLING OFF

Description	Clause	M/O/C	Min	Length
Proactive UICC command Tag	9.2	M	Y	1
Length (A+B)	-	M	Y	1 or 2
Command details	8.6	M	Y	A
Device identities	8.7	M	Y	B

6.6.15 PROVIDE LOCAL INFORMATION

Description	Clause	M/O/C	Min	Length
Proactive UICC command Tag	9.2	M	Y	1
Length (A+B)	-	M	Y	1 or 2
Command details	8.6	M	Y	A
Device Identities	8.7	M	Y	B

6.6.16 SET UP EVENT LIST

Description	Clause	M/O/C	Min	Length
Proactive UICC command Tag	9.2	M	Y	1
Length (A+B+C)	-	M	Y	1 or 2
Command details	8.6	M	Y	A
Device Identities	8.7	M	Y	B
Event list	8.25	M	Y	C

If the Event list is a null data object (i.e. length = '00' and no value part), this is an indication to the terminal to remove the existing list of events in the terminal.

6.6.17 PERFORM CARD APDU

Description	Clause	M/O/C	Min	Length
Proactive UICC command Tag	9.2	M	Y	1
Length (A+B+C)	-	M	Y	1 or 2
Command details	8.6	M	Y	A
Device Identities	8.7	M	Y	B
C-APDU	8.35	M	Y	C

6.6.18 POWER OFF CARD

Description	Clause	M/O/C	Min	Length
Proactive UICC command Tag	9.2	M	Y	1
Length (A+B)	-	M	Y	1 or 2
Command details	8.6	M	Y	A
Device Identities	8.7	M	Y	B

6.6.19 POWER ON CARD

Description	Clause	M/O/C	Min	Length
Proactive UICC command Tag	9.2	M	Y	1
Length (A+B)	-	M	Y	1 or 2
Command details	8.6	M	Y	A
Device Identities	8.7	M	Y	B

6.6.20 GET READER STATUS

Description	Clause	M/O/C	Min	Length
Proactive UICC command Tag	9.2	M	Y	1
Length (A+B)	-	M	Y	1 or 2
Command details	8.6	M	Y	A
Device Identities	8.7	M	Y	B

6.6.21 TIMER MANAGEMENT

Description	Clause	M/O/C	Min	Length
Proactive UICC command Tag	9.2	M	Y	1
Length (A+B+C+D)	-	M	Y	1 or 2
Command details	8.6	M	Y	A
Device Identities	8.7	M	Y	B
Timer Identifier	8.37	M	Y	C
Timer value	8.38	C	N	D

- Timer Identifier:
 - Contents: identifier of the timer to which the command applies.
- Timer value:
 - Contents: length of time during which the timer has to run. The UICC shall supply this data object only when a timer has to be started.

6.6.22 SET UP IDLE MODE TEXT

Description	Clause	M/O/C	Min	Length
Proactive UICC command Tag	8.2	M	Y	1
Length (A+B+C+D)	-	M	Y	1 or 2
Command details	7.5.6	M	Y	A
Device identities	7.5.7	M	Y	B
Text string	7.5.15	M	Y	C
Icon identifier	8.31	O	N	D

If the "Text string" is a null data object (i.e. length = '00' and no value part), the terminal shall remove the existing idle mode text in the terminal.

6.6.23 RUN AT COMMAND

Description	Clause	M/O/C	Min	Length
Proactive UICC command Tag	9.2	M	Y	1
Length (A+B+C+D+E)	-	M	Y	1 or 2
Command details	8.6	M	Y	A
Device Identities	8.7	M	Y	B
Alpha Identifier	8.2	O	N	C
AT Command	8.40	M	Y	D
Icon identifier	8.31	O	N	E

6.6.24 SEND DTMF COMMAND

Description	Clause	M/O/C	Min	Length
Proactive UICC command Tag	9.2	M	Y	1
Length (A+B+C+D+E)	-	M	Y	1 or 2
Command details	8.6	M	Y	A
Device Identities	8.7	M	Y	B
Alpha Identifier	8.2	O	N	C
DTMF String	8.44	M	Y	D
Icon identifier	8.31	O	N	E

6.6.25 LANGUAGE NOTIFICATION

Description	Clause	M/O/C	Min	Length
Proactive UICC command Tag	9.2	M	Y	1
Length (A+B+C)	-	M	Y	1
Command details	8.6	M	Y	A
Device identities	8.7	M	Y	B
Language	8.45	C	Y/N	C

- Language:
 - Contents: currently used language. The UICC shall include a Language object, when a specific language is being notified.

6.6.26 LAUNCH BROWSER

Description	Clause	M/O	Min	Length
Proactive UICC command Tag	9.2	M	Y	1
Length (A+B+C+D+E+F1+F2+...+FN+G+H+I)	-	M	Y	1 or 2
Command details	8.6	M	Y	A
Device Identities	8.7	M	Y	B
Browser Identity	8.47	O	N	C
URL	8.48	M	Y	D
Bearer	8.49	O	N	E
Provisioning File Reference 1	8.50	O	N	F1
Provisioning File Reference 2	8.50	O	N	F2
...	8.50	O	N	Fx
Provisioning File Reference N	8.50	O	N	FN
Text String (Gateway/Proxy Identity)	8.15	O	N	G
Alpha identifier (user confirmation phase)	8.2	O	N	H
Icon identifier (user confirmation phase)	8.31	O	N	I

If the URL data object is provisioned the URL value shall take precedence over any other URL value.

If Provisioning File Reference data object is present in the command then it shall take precedence over Bearer and Proxy Identity. If several Provisioning File References are present in the same command the information in the first reference shall take precedence.

Gateway/Proxy Identity is a text string which gives to the terminal the name/identity of the Gateway/Proxy to be used for connecting to the URL. This Gateway/Proxy Identity is required when the bearer data object is present.

6.6.27 OPEN CHANNEL

6.6.27.1 OPEN CHANNEL related to CS bearer

Description	Clause	M/O/C	Min	Length
Proactive UICC command Tag	9.2	M	Y	1
Length (A+B+C+D+E+F+G+H+I+J+K+L+M+N+O)	-	M	Y	1 or 2
Command details	8.6	M	Y	A
Device identities	8.7	M	Y	B
Alpha identifier	8.2	O	N	C
Icon identifier	8.31	O	N	D
Address	8.1	M	Y	E
Subaddress	8.3	O	N	F
Duration 1	8.8	C	N	G
Duration 2	8.8	O	N	H
Bearer description	8.52	M	Y	I
Buffer size	8.55	M	Y	J
Other address (local address)	8.58	O	N	K
Text String (User login)	8.15	O	N	L
Text String (User password)	8.15	O	N	M
UICC/terminal interface transport level	8.59	O	N	N
Data destination address	8.58	C	Y	O

The subaddress may be requested. If the subaddress is not present, the terminal shall not provide a called party subaddress to the network.

Duration 1 indicates the duration of reconnection tries. If Duration 1 is not present or is null, the UICC imposes no restrictions on the terminal. Duration 1 shall be present if Duration 2 is present.

Duration 2 indicates the timeout value before the terminal releases the link if there is no data exchanged on the link. If duration 2 is not present the link is never released automatically by the terminal.

The local address parameter provides information to the terminal necessary to identify the local device (i.e. it provides an IP address). If local address length is null, dynamic local address is required. If parameter is not present, the terminal may use the terminal default local address configuration.

The terminal may support a remote access login feature (e.g. PPP login). If supported by the terminal, the UICC may provide "User login" and "User password" parameters which allow the terminal to answer an access authentication challenge. If only one parameter is present, it is considered as the User Login and the terminal shall use default Password configuration if any. If the parameters are not present, the terminal shall use default Login/Password configuration if any. If no authentication challenge is requested, the user login and password parameters shall be ignored.

If the UICC/terminal interface transport level is present in the command, then the terminal shall provide the requested transport layer protocols under the channel and shall use this object containing a set of parameters required to make the transport connection. The data that is exchanged at the UICC/terminal interface in the RECEIVE DATA/SEND DATA commands are SDUs. When the CAT application sends an SDU, the transport layer within the terminal is in charge to add the transport header to the SDU in order to build the Transport-PDU. When the CAT application requests to receive an SDU, the transport layer within the terminal is in charge to remove the transport header of the Transport-PDU, and to forward the SDU to the CAT. If the parameter is not present, the UICC/terminal interface is the bearer level (serial link or packet link), and the CAT application is in charge of the network and transport layer.

The Data destination address is the end point destination address of sent data. This data destination address is requested when a UICC/terminal interface transport is present, otherwise it is ignored. The data destination address is a data network address.

6.6.27.2 OPEN CHANNEL related to packet data service bearer

Description	Clause	M/O/C	Min	Length
Proactive UICC command Tag	9.2	M	Y	1
Length (A+B+C+D+E+F+G+H+I+J+K+L)	-	M	Y	1 or 2
Command details	8.6	M	Y	A
Device identities	8.7	M	Y	B
Alpha identifier	8.2	O	N	C
Icon identifier	8.31	O	N	D
Bearer description	8.52	M	Y	E
Buffer size	8.55	M	Y	F
Network Access Name	8.70	O	N	G
Other address (local address)	8.58	O	N	H
Text String (User login)	8.15	O	N	I
Text String (User password)	8.15	O	N	J
UICC/terminal interface transport level	8.59	O	N	K
Data destination address	8.58	C	Y	L

The Network Access Name may be requested. The Network Access Name provides information to the terminal necessary to identify the Gateway entity which provides interworking with an external packet data network. If the parameter is not present, the terminal may use the default Network Access Name in the terminal configuration or the default subscription value.

The local address parameter provides information to the terminal necessary to identify the local device. If the parameter is present and length is not null, it provides an IP address that identifies the CAT application in the address area applicable to the PDN. If local address length is null, dynamic local address allocation is required for the CAT application. If parameter is not present, the terminal may use the terminal default local address configuration.

The TE may support a remote access login feature. If supported by the TE, the UICC may provide 'User login' and 'User password' parameters, which can be used for authentication. If only one parameter is present, it is considered as the User Login and the TE shall use default Password configuration if any. If the parameters are not present, the TE shall use default Login/Password configuration if any. If no authentication is requested, the user login and password parameters shall be ignored.

If the UICC/terminal interface transport level is present in the command, then the terminal shall provide the requested transport layer protocols under the channel and shall use this object containing a set of parameters required to make the transport connection. The data that is exchanged at the UICC/terminal interface in the RECEIVE DATA/SEND DATA commands are SDUs. When the CAT application sends an SDU, the transport layer within the terminal is in charge to add the transport header to the SDU in order to build the Transport-PDU. When the SAT application requests to receive an SDU, the transport layer within the terminal is in charge to remove the transport header of the Transport-PDU, and to forward the SDU to the CAT. If the parameter is not present, the UICC/terminal interface is the bearer level (serial link or packet link), and the CAT application is in charge of the network and transport layer.

The Data destination address is the end point destination address of sent data. This data destination address is requested when a UICC/terminal interface transport is present, otherwise it is ignored. The data destination address is a data network address (e.g. IP address).

6.6.27.3 OPEN CHANNEL related to local bearer

Description	Clause	M/O/C	Min	Length
Proactive UICC command Tag	9.2	M	Y	1
Length (A+B+C+D+E+F+G+H+I+J+K+L)	-	M	Y	1 or 2
Command details	8.6	M	Y	A
Device identities	8.7	M	Y	B
Alpha identifier	8.2	O	N	C
Icon identifier	8.31	O	N	D
Duration 1	8.8	C	N	E
Duration 2	8.8	O	N	F
Bearer description	8.52	M	Y	G
Buffer size	8.55	M	N	H
Text String (User password)	8.15	O	N	I
UICC/terminal interface transport level	8.59	O	N	J
Data destination address	8.58	C	Y	K
Remote Entity Address	8.68	O	N	L

Duration 1 indicates the duration of reconnection tries. If Duration 1 is not present or is null, the UICC imposes no restrictions on the terminal. Duration 1 shall be present if Duration 2 is present.

Duration 2 indicates the timeout value before the terminal releases the link if there is no data exchanged on the link. If duration 2 is not present the link is never released automatically by the terminal.

Bearer Description gives detailed information characterizing the bearer. When the UICC acts as a server, local information (local service record data) is included in Bearer Description; in addition, if the UICC provides a Service Record field (which is part of the Bearer Description TLV) different from '00', the terminal shall ignore it and proceed with the command. When the UICC acts as a client, remote information (remote service record data) is included in Bearer Description; in addition, if the UICC provides a Service Identifier field (which is part of the Bearer Description TLV) different from 'FF', the terminal shall ignore it and proceed with the command.

The UICC may optionally provide a user password that should be used by the terminal for authentication. For the Bluetooth local bearer, the user password corresponds to the passkey/PIN as defined in the Bluetooth specification [16].

If the UICC/terminal interface transport level is present in the command, then the terminal shall provide the requested transport layer protocols under the channel and shall use this object containing a set of parameters required to make the transport connection. If the parameter is not present, the UICC/terminal interface is the bearer level. The data that will be received/sent from the SAT to the transport layer is a SDU that will be received/transmitted in the Transport-PDU.

The Data destination address is the end point destination address of sent data. This data destination address is requested when a UICC/terminal interface transport is present, otherwise it is ignored. The data destination address is a data network address (e.g. IP address).

The Remote Entity Address parameter provides information to the terminal necessary to identify the entity which provides access to the requested resource. Depending on the local technology, this parameter is necessary or not. For Bluetooth, it shall be the BD_ADDR of the remote device.

6.6.28 CLOSE CHANNEL

Description	Clause	M/O	Min	Length
Proactive UICC command Tag	9.2	M	Y	1
Length (A+B+C+D)	-	M	Y	1 or 2
Command details	8.6	M	Y	A
Device Identities	8.7	M	Y	B
Alpha identifier	8.2	O	N	C
Icon identifier	8.31	O	N	D

6.6.29 RECEIVE DATA

Description	Clause	M/O	Min	Length
Proactive UICC command Tag	9.2	M	Y	1
Length (A+B+C+D+E)	-	M	Y	1 or 2
Command details	8.6	M	Y	A
Device Identities	8.7	M	Y	B
Alpha identifier	8.2	O	N	C
Icon identifier	8.31	O	N	D
Channel data length	8.54	M	Y	E

6.6.30 SEND DATA

Description	Clause	M/O	Min	Length
Proactive UICC command Tag	9.2	M	Y	1
Length (A+B+C+D+E)	-	M	Y	1 or 2
Command details	8.6	M	Y	A
Device identities	8.7	M	Y	B
Alpha identifier	8.2	O	N	C
Icon identifier	8.31	O	N	D
Channel data	8.53	M	Y	E

6.6.31 GET CHANNEL STATUS

Description	Clause	M/O	Min	Length
Proactive UICC command Tag	9.2	M	Y	1
Length (A+B)	-	M	Y	1 or 2
Command details	8.6	M	Y	A
Device identities	8.7	M	Y	B

6.6.32 SERVICE SEARCH

Description	Clause	M/O	Min	Length
Proactive UICC command Tag	9.3	M	Y	1
Length (A+B+C+D+E+F)	-	M	Y	1 or 2
Command details	8.6	M	Y	A
Device Identities	8.7	M	Y	B
Alpha identifier	8.2	O	N	C
Icon identifier	8.31	O	N	D
Service search	8.65	M	Y	E
Device filter	8.64	O	N	F

6.6.33 GET SERVICE INFORMATION

Description	Clause	M/O	Min	Length
Proactive UICC command Tag	9.3	M	Y	1
Length (A+B+C+D+E)	-	M	Y	1 or 2
Command details	8.6	M	Y	A
Device Identities	8.7	M	Y	B
Alpha identifier	8.2	O	N	C
Icon identifier	8.31	O	N	D
Attribute information	8.66	M	Y	E

6.6.34 DECLARE SERVICE

Description	Clause	M/O	Min	Length
Proactive UICC command Tag	9.3	M	Y	1
Length (A+B+C+D)	-	M	Y	1 or 2
Command details	8.6	M	Y	A
Device Identities	8.7	M	Y	B
Service Record	8.63	M	Y	C
UICC/terminal interface	8.59	O	N	D

For Device identities field, Destination Device Identity is required to be the terminal.

The UICC/terminal interface parameter specifies the protocol stack the UICC will be connected to on the terminal.

If the UICC/terminal interface data object is not present, the UICC/terminal interface is the bearer level as defined in the OPEN CHANNEL command.

6.7 Command results

Once the terminal has made its attempt to execute a proactive command from the UICC, the terminal shall inform the UICC of the success or otherwise of that command, by using TERMINAL RESPONSE. This message gives the command details, including the number of the command (see clause 6.5.1), a general result, and sometimes more specific information.

Three overall categories of results are defined:

- command performed successfully. This is returned by the terminal for every successful command;
- temporary problem with executing command. These are further defined below, but generally these indicate to the UICC that it is worth trying again later;
- permanent problem with executing command. These are further defined below, but generally indicate that the same command will end in the same result if repeated during the same card session.

Successful commands are further defined as:

- command performed successfully. There were no problems;
- command performed with partial comprehension. Here the terminal receives a command with one or more SIMPLE-TLV data objects that are unrecognized or unexpected, all of which do not have their "comprehension required" flag set (see clause 9.3), but the parent BER-TLV data object still has the minimum set of SIMPLE-TLV data objects required to perform the command;
- command performed, with missing information. The terminal received at least the minimum set of component parts, but did not receive all of the parts that it believed mandatory for the UICC to send;
- REFRESH performed with additional EFs read (see clause 6.4.7);
- command performed successfully but requested icon could not be displayed;
- command performed, but modified by call control. This is sent by the terminal to indicate that call control modified the type of request indicated in the proactive command, and that the action requested by call control was performed successfully;
- command performed with modification. This is sent by the terminal to indicate that it is unable to process the command using the exact parameters provided by the UICC. The command is processed with the best possible parameters;
- command performed successfully, limited service;
- REFRESH performed but indicated NAA was not active.

Temporary problems are further defined as:

- terminal is currently unable to process the command. Specific causes for this are:
 - the screen is busy;
 - terminal currently busy on a call;
 - terminal currently busy on SEND DTMF operation;
 - no service is currently available;
 - access control class barred on serving network;
 - no radio resource currently available;
 - not in speech call;
 - no NAA active;
- if none of these can be made to apply, a "no cause can be given" value can be used;
- network is currently unable to process the command. Specific cause values may additionally be provided;
- in some proactive commands, the terminal is required to solicit and receive approval of the user before executing the proactive command. In the case that the user does not give approval for the execution of the proactive command, it shall not be executed by the terminal and the terminal response "user did not accept the proactive command" shall be returned by the terminal to the UICC;
- the user cleared down the call, before the call connected or before the network released the call;
- action in contradiction with the current timer state. This is where the UICC requests an action for a timer to be taken by the terminal and the state of the timer does not allow that action;
- interaction with call control by UICC, temporary problem. This is sent by the terminal to indicate that call control modified the type of request indicated in the proactive command, and that the action requested by call control encounters a temporary problem.

Permanent problems are further defined as:

- command is beyond terminal's capabilities. This is sent by the terminal when it understands what the UICC is asking it to do, but does not have the capability to do it, e.g. terminal which only supports SMS asked to set up a call;
- command type not understood by terminal. This is sent by the terminal when the UICC sends a command with the Type of Command byte set to a value the terminal does not know. This is to allow future expansion of commands;
- command data not understood by terminal. This is sent by the terminal when the command type is understood by the terminal, but the related data object(s) are not, e.g. reserved values have been included in a data object, or one or more unknown SIMPLE-TLV data objects have a "comprehension required" tag;
- error, required values are missing. This is given when the command type is understood by the terminal, but it does not receive the minimum set of SIMPLE-TLV data objects that it requires to perform the command. These components are shown by the "Min" column in the command structure definitions;
- interaction with call control by NAA by NAA, permanent problem. This is sent by the terminal to indicate that:
 - call control by NAA does not allow the action corresponding to the proactive command; or
 - call control by NAA has modified the type of request indicated in the proactive command and that the action requested by call control encounters a permanent problem;

- specific cause values for this are:
 - action not allowed;
 - the type of request has changed;
 - Current Access Technology unable to process command. This is given to the NAA when terminal is unable to process the requested command due to the current access technology in use;
- if none of these can be made to apply, a "no cause can be given" value can be used.

6.8 Structure of TERMINAL RESPONSE

Direction: terminal to UICC.

The command header is specified in TS 102 221 [1] for a 3G platform and in TS 151 011 [8] for a 2G platform. Length (A + B + ... + Y) is indicated by P3 of the header.

Command parameters/data.

Description	Clause	M/O/C	Min	Length
Command details	8.6	M	Y	A
Device identities	8.7	M	N	B
Result	8.12	M	Y	C
Duration (only required in response to a POLL INTERVAL proactive command)	8.8	C	N	D
Text string (only required in response to a GET INKEY or GET INPUT proactive command)	8.15	C	N	E
Item identifier (only required in response to SELECT ITEM proactive command)	8.10	C	N	F
Local information (only required in response to PROVIDE LOCAL INFORMATION proactive command)	8.19, 8.20, 8.22, 8.29, 8.39, 8.45, 8.46, 8.61, 8.63	C	N	G
Call control requested action (only required if call control by NAA has modified a proactive command SET UP CALL in another type of request)	8.30	C	N	H
Result data object 2 (only required if call control by NAA has modified a proactive command SET UP CALL in another type of request)	8.12	C	N	I
Card reader status (only required in response to GET READER STATUS command). According to the requested information, one Card reader status object for each card interface reported, or one Card reader identifier object is required	8.33, 8.57	C	N	J ₀ + ... + J _n , or J
Card ATR (only required in response to POWER ON CARD)	8.34	C	N	K
R-APDU (only required in response to PERFORM CARD APDU)	8.36	C	N	L
Timer identifier (only required in response to a TIMER MANAGEMENT proactive command)	8.37	C	N	M
Timer value (only required in response to a TIMER MANAGEMENT proactive command)	8.38	C	N	N
AT Response (only required in response to RUN AT COMMAND proactive command)	8.41	C	N	P
Channel data (only required in response to RECEIVE DATA)	8.54	C	N	R

Description	Clause	M/O/C	Min	Length
Channel status (only required in response to GET CHANNEL STATUS or OPEN CHANNEL proactive command)	8.56	C	N	$S_0 + \dots + S_n$
Channel data length (only required in response to RECEIVE DATA or SEND DATA proactive command)	8.54	C	N	T
Bearer description (only required in response to OPEN CHANNEL proactive command)	8.52	C	N	U
Buffer size (only required in response to OPEN CHANNEL proactive command)	8.55	C	N	V
Total display duration (only required in response to a GET INKEY proactive command)	8.8	C	N	W
Service availability (only required in response to SERVICE SEARCH proactive command)	8.67	C	N	X
Service record (only required in response to GET SERVICE INFORMATION proactive command)	8.63	C	N	Y

Under no circumstances shall the UICC wait indefinitely for a TERMINAL RESPONSE.

For all the Conditional (C) SIMPLE-TLV objects, the terminal should not include them in the response to non-applicable situations. However, if one is present, the UICC shall ignore it.

For all SIMPLE-TLV objects with Min = N, the terminal should set the CR flag to comprehension not required. Any future additional SIMPLE-TLV objects will be included as Min = N and comprehension not required. This will ensure that any proactive command will end in a predictable way.

Response parameters/data: None.

6.8.1 Command details

This data object shall be identical to the command details data object (including the comprehension required flag) given by the UICC in the proactive command to which the terminal is giving the result:

- if the terminal has not received a valid Command number, all Command Details object values shall be set to '00' and the Result shall indicate an error;
- if the failure is caused by a problem on the transmission layer, the terminal shall respond with "temporary problem" ("terminal currently not able to process command"). If not, the terminal shall respond with "permanent problem" (either "command not understood by terminal" or "Error required values are missing");
- the UICC shall interpret a terminal Response with a command number '00' as belonging to the last proactive command having been sent to the terminal.

6.8.2 Device identities

The terminal shall set the device identities to:

- source: terminal;
- destination: UICC.

6.8.3 Result

This data object holds the result of the proactive UICC command.

6.8.4 Duration

When the terminal issues a successful TERMINAL RESPONSE for a POLL INTERVAL command, it shall state the polling interval it will be using in the Duration data object.

6.8.5 Text string

When the terminal issues a successful TERMINAL RESPONSE ('0X' result value - refer to clause 8.12) for a GET INKEY or GET INPUT command, it shall supply the single character or the character string entered by the user in the Text string data object. When the terminal issues a successful TERMINAL RESPONSE ('0X' result value - refer to clause 8.12) for a GET INKEY ("Yes/No") command with command qualifier set to "Yes/No", it shall supply the value '01' when the answer is "positive" and the value '00' when the answer is "negative" in the text string data object.

When the terminal issues a successful TERMINAL RESPONSE ('0X' result value - refer to clause 8.12) for a GET INPUT command to which the user has made an empty input (i.e. if the user does not enter any character), the terminal shall indicate this by means of either a null text string (see clause 8.15 for the coding of this object), or by means of a Text string object with Length = '01', and a Value part consisting of a data coding scheme only.

NOTE: The notion of empty input is different from the general result "no response from user" (see clause 8.12). The latter event is typically caused by a timeout in the MMI, whereas an empty input requires an acknowledgement from the user.

6.8.6 Item identifier

When the terminal issues a successful TERMINAL RESPONSE ('0X' result value - refer to clause 8.12) for a SELECT ITEM command, it shall supply the identifier of the item selected by the user in the Item identifier data object. If the terminal issues a TERMINAL RESPONSE with result "Help information required by the user" for a SELECT ITEM command, it shall supply the identifier of the item for which the user is requiring help information.

6.8.7 Local information

When the terminal issues a successful TERMINAL RESPONSE for a PROVIDE LOCAL INFORMATION command, it shall supply the requested local information.

- Where the UICC has requested location information, TERMINAL RESPONSE shall contain the location information data object.
- Where the UICC has requested the IMEI, TERMINAL RESPONSE shall contain the IMEI data object.
- Where the UICC has requested the Network Measurement Results the TERMINAL RESPONSE shall contain the NMR data object and the BCCH channel list data object if supported by the network access technology.
- Where the UICC has requested the date, time and time zone the TERMINAL RESPONSE shall contain the Date-Time and Time zone data object.
- Where the UICC has requested the currently used language, the TERMINAL RESPONSE shall contain the Language data object.
- Where the UICC has requested the Timing Advance, the TERMINAL RESPONSE shall contain the Timing Advance data object if supported by the network access technology.
- Where the UICC has requested the Access Technology, the TERMINAL RESPONSE shall contain the Access Technology data object.
- Where the UICC has requested the ESN, TERMINAL RESPONSE shall contain the ESN data object.

6.8.8 Call control requested action

When the terminal issues a TERMINAL RESPONSE for a proactive command SET UP CALL which has been modified by call control by UICC in another type of request, it shall supply the response data given in response to the ENVELOPE (CALL CONTROL).

6.8.9 Result data object 2

When the terminal issues a TERMINAL RESPONSE for a proactive command SET UP CALL which has been modified by call control by UICC in another type of request, it shall supply the Result data object it would have supplied for the proactive command equivalent to the action requested by call control, and given in the Call control request data element.

6.8.10 Card reader status

This clause applies if class "a" is supported.

When the terminal issues a successful TERMINAL RESPONSE for a GET READER STATUS command, it shall supply the requested readers' information:

- Where the UICC has requested the card reader status, TERMINAL RESPONSE shall supply the status of each card reader in n consecutive Card reader status data objects, where n is the card reader count.
- Where the UICC has requested the card reader identifier, TERMINAL RESPONSE shall supply the identifier of the requested card reader identifier.

6.8.11 Card ATR

This clause applies if class "a" is supported.

When the terminal issues a successful TERMINAL RESPONSE for a POWER ON CARD command, it shall supply the ATR returned by the addressed card in the Card ATR data object.

6.8.12 R-APDU

This clause applies if class "a" is supported.

When the terminal issues a successful TERMINAL RESPONSE for a PERFORM CARD APDU command, it shall supply the response data and status words in the R-APDU data object.

6.8.13 Timer identifier

When the terminal issues a successful TERMINAL RESPONSE for a TIMER MANAGEMENT, it shall state in the timer identifier data object the identifier of the timer to which this command applies.

6.8.14 Timer value

When the terminal issues a successful TERMINAL RESPONSE for a TIMER MANAGEMENT command with command qualifier indicating "deactivate" or "get the current value of the timer", it shall state in the timer value data object the current value of the timer.

6.8.15 AT Response

This clause applies if class "b" is supported.

When the terminal issues a successful TERMINAL RESPONSE for a RUN AT COMMAND command, the TERMINAL RESPONSE shall contain the AT Response (as defined in clause 8.40).

6.8.16 Text string 2

The presence of this object is access technology dependant.

6.8.17 Channel data

This clause applies if class "e" is supported.

When the terminal issues a successful TERMINAL RESPONSE for a RECEIVE DATA command, the TERMINAL RESPONSE shall contain the Channel Data data object.

6.8.18 Channel status

This clause applies if class "e" is supported.

When the terminal issues a successful TERMINAL RESPONSE for a GET CHANNEL STATUS proactive command, the TERMINAL RESPONSE shall contain as many Channel Status data objects as there are available channels.

When the terminal issues a successful TERMINAL RESPONSE for an OPEN CHANNEL command, the TERMINAL RESPONSE shall contain a Channel status data object for the opened channel.

6.8.19 Channel data length

This clause applies if class "e" is supported.

When the terminal issues a successful TERMINAL RESPONSE for a RECEIVE DATA command or a SEND DATA, the TERMINAL RESPONSE shall contain the Channel Data Length data object.

6.8.20 Bearer description

This clause applies if class "e" is supported.

When the terminal issues a successful or an unsuccessful TERMINAL RESPONSE for an OPEN CHANNEL command, the TERMINAL RESPONSE shall contain the Bearer description data object.

6.8.21 Buffer size

This clause applies if class "e" is supported.

When the terminal issues a successful or an unsuccessful TERMINAL RESPONSE for an OPEN CHANNEL command, the TERMINAL RESPONSE shall contain the Buffer size data object.

6.8.22 Total Display Duration

When the terminal issues a TERMINAL RESPONSE for a GET INKEY proactive command with variable timeout, it shall supply the total display text duration (*command execution duration*). The time unit of the response is identical to the time unit of the requested variable timeout.

Resolution and the precision of the time value are in accordance with clause 6.4.21.

6.8.23 Service Availability

This clause applies if class "f" is supported.

When the terminal issues a successful TERMINAL RESPONSE for a SERVICE SEARCH command, the TERMINAL RESPONSE shall contain the Service Availability data object.

6.8.24 Service Record

This clause applies if class "f" is supported.

When the terminal issues a successful TERMINAL RESPONSE for a GET SERVICE INFORMATION command, the TERMINAL RESPONSE shall contain the Service Record data object.

6.9 Proactive UICC session and terminal display interaction

During a proactive session the terminal display shall be refreshed by any display data contained in the first and each subsequent proactive command. The refresh shall occur once the terminal has retrieved the proactive command using the Fetch instruction, following the proactive command pending status response.

If no proactive command is pending (status response of '90 00' following the terminal Response), then the session releases the display back into terminal control. If this session was terminated in a backwards move, and the session was initiated from an Envelope command containing a Menu Selection, it is recommended that the display returns to the Setup Menu.

If the text is to be sustained, the terminal shall display the text of applicable DISPLAY TEXT commands beyond the sending of the TERMINAL RESPONSE and possibly beyond the end of the proactive session.

If a variable display timeout was indicated for a DISPLAY TEXT command, then the session releases the display back into terminal control no later than the period stated by the duration. If the text is to be sustained beyond an immediate response, the terminal shall display the text for a period that does not exceed the duration.

6.10 Handling of unknown, unforeseen and erroneous messages

6.10.1 General

The procedures described in this clause apply to the BER-TLV and SIMPLE-TLV data objects described in the present document. The purpose of this clause is to allow greater flexibility in future versions of the present document, and a greater predictability across different versions of the present document.

The procedures described here specify how the terminal and UICC shall behave when they receive a proactive command or response that is not fully compliant with the standards by which it was designed. A response will be made to the UICC by means of the "general result" field of the "result".

If the terminal sends a FETCH or TERMINAL RESPONSE to the UICC that contains values that the UICC does not understand, then the UICC shall issue the appropriate SW1/SW2 error response. The current proactive transaction shall be considered complete and neither the terminal or the UICC shall take no further action with regard to it. In this case, unless the "General result" is "command performed..." then the UICC shall assume that the command was not carried out and that a permanent error exists with regard to that particular proactive command. If the command was performed, but the "additional information on result" field was not understood, then the UICC may attempt the command again at a later stage in the current card session.

If the UICC has enough information to proceed (i.e. it has received all the data objects of the Minimum set) then it shall do so.

6.10.2 Message too short

Any information received that is not a complete tag and length shall be ignored.

6.10.3 Missing minimum information

If a message is received that does not have all the mandatory elements in it, then if all of the minimum set elements are present then the receiver shall complete the command and report "command performed, with missing information".

If the minimum set of elements is not complete, then the terminal shall respond with "Error, required values are missing".

6.10.4 Unknown Tag value

If a BER-TLV object is received that has a tag that is understood, but contains SIMPLE-TLV components that have unknown tags, then provided the minimum set condition is fulfilled, the "comprehension required" bit of the tag shall determine how the receiving entity behaves.

If the comprehension required flag in an unknown tag is set to '1', and the terminal either does not recognize or is not expecting one or more of the SIMPLE-TLV objects in the message, then it shall respond with "Command data not understood by terminal".

If the comprehension required flag is set to '0', then the terminal shall read the length field that follows and ignore that object. In this case the terminal will be able to carry out the command without the SIMPLE-TLV components that it cannot understand. It shall respond with "command performed with partial comprehension".

6.10.5 Unexpected Tag value

If a BER-TLV object is received that contains elements that have recognizable tags, but which were not expected in the context of this message (for example, the terminal sees SMS TDPU tag as part of DISPLAY TEXT), then it shall discard that element. It shall then proceed as described for Unknown Tag values.

If a received object has a tag that has already been received, then the first instance shall be used and any subsequent instances shall be discarded.

6.10.6 Length errors

If the total lengths of the SIMPLE-TLV data objects are not consistent with the length given in the BER-TLV data object, then the whole BER-TLV data object shall be rejected. The result field in the TERMINAL RESPONSE shall have the error condition "Command data not understood by terminal".

If the length of the BER-TLV data object is shorter than the length of the response data, the terminal shall ignore response data following the complete BER-TLV data object. If the length of the BER-TLV data object is longer than the length of the response data, then clauses 6.10.2 and 6.10.3 apply.

6.10.7 Contents not understood

If the contents of a SIMPLE-TLV data object contains a field with a value that is defined as reserved, then the whole SIMPLE-TLV data object shall be considered as invalid. It will then depend on the "comprehension required" bit of the relevant tag as to whether the whole BER-TLV data object shall be rejected, or whether that particular SIMPLE-TLV data object shall be ignored.

If the contents of a BER-TLV object contain RFU bits or bytes, then these shall be ignored.

6.10.8 Extended length data objects

If a SIMPLE-TLV data object has a length longer than expected (i.e. more information has been added), then the receiver shall ignore this extra information to the end of the object. The end of the object shall be found by looking at the "length" field of that object.

NOTE: If comprehension of the extra bytes is required, this can be achieved by the use of a reserved coding in an earlier field.

6.11 Proactive commands versus possible terminal response

Table 6.1 shows for each proactive command the possible terminal response returned (marked by a "•" character).

Table 6.1: Proactive commands versus possible terminal response (continued overleaf...)

TERMINAL RESPONSE		PROACTIVE COMMAND																			
		RE-FRESH	MORE TIME	POLL INTERVAL	POLLING OFF	SETUP EVENT LIST	SET UP CALL				SEND DTMF	LAUNCH BROWSER	PLAY TONE	DISPLAY TEXT	GET INKEY	GET INPUT	SELECT ITEM	SET UP MENU	PROVIDE LOCAL INFO	TIMER MANAGEMENT	SET-UP IDLE MODE TEXT
		'01'	'02'	'03'	'04'	'05'	'10'				'14'	'15'	'20'	'21'	'22'	'23'	'24'	'25'	'26'	'27'	'28'
00	Command performed successfully	•	•	•	•	•	•				•	•	•	•	•	•	•	•	•	•	•
01	Command performed with partial comprehension	•	•	•	•	•	•				•	•	•	•	•	•	•	•	•	•	•
02	Command performed, with missing information	•	•	•	•	•	•				•	•	•	•	•	•	•	•	•	•	•
03	REFRESH performed with additional EFs read	•																			
04	Command performed successfully, but requested icon could not be displayed						•				•		•	•	•	•	•	•			
05	Command performed, but modified by call control by NAA						•														
06	Command performed successfully, limited service																		•		
07	Command performed with modification																				
08	REFRESH performed but indicated NAA was not active	•																			
10	Proactive UICC session terminated by the user						•				•		•	•	•	•	•				
11	Backward move in the proactive UICC session requested by the user													•	•	•	•				
12	No response from user													•	•	•	•				
13	Help information required by the user														•	•	•				
14	Reserved for 3GPP						•														
20	Terminal currently unable to process command	•	•	•	•	•	•				•	•	•	•	•	•	•	•	•	•	•
21	Network currently unable to process command						•					•									
22	User did not accept the proactive command						•														
23	User cleared down call before connection or network release						•														
24	Action in contradiction with the current timer state																			•	
25	Interaction with call control by NAA, temporary problem						•														
26	Launch browser generic error											•									
30	Command beyond MEs capabilities	•	•	•	•	•	•				•	•	•	•	•	•	•	•	•	•	•
31	Command type not understood by terminal	•	•	•	•	•	•				•	•	•	•	•	•	•	•	•	•	•
32	Command data not understood by terminal	•	•	•	•	•	•				•	•	•	•	•	•	•	•	•	•	•
33	Command number not known by terminal	•	•	•	•	•	•				•	•	•	•	•	•	•	•	•	•	•
34	Reserved for 3GPP						•														
35	Reserved for 3GPP										•										
36	Error, required values are missing	•	•	•	•	•	•				•		•	•	•	•	•	•	•	•	•
37	Reserved for 3GPP																				
38	Multiple Card command error																				
39	Interaction with call/SM control by NAA, permanent problem						•														
3A	Bearer Independent Protocol error																				
3B	Access Technology unable to process command																				

Table 6.1: Proactive commands versus possible terminal response

TERMINAL RESPONSE		PROACTIVE COMMAND																	
		CARD APDU	POWER ON CARD	POWER OFF CARD	GET READER STATUS	RUN AT COMMAND	LANG NOTIFICATION	OPEN CHANNEL	CLOSE CHANNEL	RECEIVE DATA	SEND DATA	GET CHANNEL STATUS	SERVICE SEARCH	GET SERVICE INFORMATION	DECLARE SERVICE				
00	Command performed successfully	'30'	'31'	'32'	'33'	'34'	'35'	'40'	'41'	'42'	'43'	'44'	'45'	'46'	'47'				
01	Command performed with partial comprehension	•	•	•	•	•	•	•	•	•	•	•	•	•	•				
02	Command performed, with missing information	•	•	•	•	•	•	•	•	•	•	•	•	•	•				
03	REFRESH performed with additional EFs read																		
04	Command performed successfully, but requested icon could not be displayed							•	•	•	•	•	•	•					
05	Command performed, but modified by call control by NAA																		
06	Command performed successfully, limited service																		
07	Command performed with modification							•							•				
08	REFRESH performed but indicated NAA was not active							•											
10	Proactive UICC session terminated by the user							•	•	•	•	•	•	•					
11	Backward move in the proactive UICC session requested by the user																		
12	No response from user																		
13	Help information required by the user																		
14	Reserved for 3GPP																		
20	Terminal currently unable to process command	•	•	•	•	•	•	•	•	•	•	•	•	•	•				
21	Network currently unable to process command							•		•									
22	User did not accept the proactive command							•											
23	User cleared down call before connection or network release																		
24	Action in contradiction with the current timer state																		
25	Interaction with call control by NAA, temporary problem							•											
26	Launch browser generic error																		
30	Command beyond MEs capabilities	•	•	•	•	•	•	•	•	•	•	•	•	•	•				
31	Command type not understood by terminal	•	•	•	•	•	•	•	•	•	•	•	•	•	•				
32	Command data not understood by terminal	•	•	•	•	•	•	•	•	•	•	•	•	•	•				
33	Command number not known by terminal	•	•	•	•	•	•	•	•	•	•	•	•	•	•				
34	Reserved for 3GPP																		
35	Reserved for 3GPP																		
36	Error, required values are missing	•	•	•	•	•	•	•	•	•	•	•	•	•	•				
37	Reserved for 3GPP																		
38	Multiple Card command error	•	•	•	•														
39	Interaction with call/SM control by NAA, permanent problem																		
3A	Bearer Independent Protocol error							•	•	•	•		•	•	•				
3B	Access Technology unable to process command							•					•	•					

7 ENVELOPE commands

7.1 Void

7.2 Menu selection

A set of possible menu options can be supplied by the UICC using the proactive command SET UP MENU. If the UICC has sent this command, and the user subsequently chooses an option or, the user requests help on it, the terminal informs the UICC using this procedure.

7.2.1 Procedure

The terminal shall follow the procedure below.

- When the terminal receives a menu selection from one of the menu items defined by a "SET-UP MENU" command issued previously by the UICC, or the user has indicated the need to get help information on one of these menu items, then it shall pass the identifier of the selected menu item to the UICC using the ENVELOPE (MENU SELECTION) command, as defined in clause 7.2.2.
- If the UICC responds with '93 00', the ME shall not re-issue this particular envelope.

7.2.2 Structure of ENVELOPE (MENU SELECTION)

Direction: terminal to UICC.

The command header is specified in TS 102 221 [1] for a 3G platform and in TS 151 011 [8] for a 2G platform.

Command parameters/data.

Description	Clause	M/O/C	Min	Length
Menu Selection tag	9.1	M	Y	1
Length (A+B+C)	-	M	Y	1 or 2
Device identities	8.7	M	Y	A
Item identifier	8.10	M	Y	B
Help request	8.21	O	N	C

Device identities: the terminal shall set the device identities to:

- source: Keypad;
- destination: UICC.

Help request: inclusion of this data object depends upon whether the user actually selected the named menu item or just requested help information on it. If the user actually selected the menu item, this data object shall not be included. If the user indicated the need to get help information on the menu item, this data object shall be included.

Response parameters/data: None for this type of ENVELOPE command.

7.3 Call Control by NAA

7.3.1 Call Control by NAA

7.3.1.1 Procedure for mobile originated calls

If the service "call control" is available in the Service Table provided by the NAA, then the terminal shall follow the procedure below:

- for all call set-up attempts (even those resulting from a SET UP CALL proactive UICC command, from the Bearer Independent Protocol proactive UICC commands where CSD is selected, or those occurring when another call is already in progress, and those resulting from automatic redial attempts), the terminal shall first pass the call set-up details (dialled digits and associated parameters) to the UICC, using the ENVELOPE (CALL CONTROL) command defined below. The "Location Information" shall be the current information, even for automatic redial attempts. CAT applications should take into account the following exception;
 - when the user is dialling an emergency call code, for which the terminal sets up an emergency call instead of passing the call set-up details to the UICC;
- if the UICC responds with '90 00', the terminal shall set up the call with the dialled digits and other parameters as sent to the UICC;
- if the UICC responds with '93 00', the terminal shall not set up the call and may retry the command;
- if the UICC provides response data, then the response data from the UICC shall indicate to the terminal whether to set up the call as proposed, not set up the call, set up a call using the data supplied by the UICC. It is mandatory for the terminal to perform the call set-up request in accordance with the data from the UICC, if it is within the terminal's capabilities to do so. If the UICC requires a call set-up that is beyond the terminal's capabilities (e.g. the UICC maps a speech call to a data call, and the terminal does not support data calls), then the terminal shall not perform the call set-up request at all. It is possible for the UICC to request the terminal to set up an emergency call by supplying the number "112" as the response data.

In the case where the initial call set-up request results from a proactive command SET UP CALL:

- if the call control result is "not allowed", the terminal shall inform the UICC using TERMINAL RESPONSE "interaction with call control by UICC by UICC, action not allowed".

If the terminal supports the Last Number Dialed service, the terminal shall update EF_{LND} with the call set-up details (digits string and associated parameters) corresponding to the initial user request.

The terminal shall then follow the call set-up procedure defined in the relevant Access Technology specification.

7.3.1.2 Void

7.3.1.3 Indication to be given to the user

The UICC may optionally include an alpha-identifier in the response data to the ENVELOPE (CALL CONTROL) message, in order to inform the user at the time the response is received by the terminal. The use of this alpha identifier by the terminal is described below:

- if the UICC responds with "allowed, no modification", then:
 - if the alpha identifier is provided by the UICC and is not a null data object, the terminal shall use it to inform the user during the call set-up;
 - if the alpha identifier is provided by the UICC and is a null data object (i.e. length = '00' and no value part), this is an indication that the terminal should not modify the display corresponding to the initial user request;
 - if the alpha identifier is not provided by the UICC, the terminal may give information to the user concerning what is happening;

- if the UICC responds with "not allowed", then:
 - if the alpha identifier is provided by the UICC and is not a null data object, the terminal shall use it to inform the user. This is also an indication that the terminal should not give any other information to the user on the reason of the barring;
 - if the alpha identifier is provided by the UICC and is a null data object (i.e. length = '00' and no value part), the terminal may give information to the user concerning what is happening;
 - if the alpha identifier is not provided by the UICC, the terminal may give information to the user concerning what is happening.
- if the UICC responds with "allowed, with modifications", and the modified request is within the terminal's capabilities, then:
 - if the alpha identifier is provided by the UICC and is not a null data object, the terminal shall use it to inform the user. The terminal shall then not display the destination address given by the UICC. This is also an indication that the terminal should not give any other information to the user on the changes made by the UICC to the initial user request;
 - if the alpha identifier is provided by the UICC and is a null data object (i.e. length = '00' and no value part), this is an indication that the terminal should not give any information to the user on the changes made by the UICC to the initial user request. The terminal shall not display the destination address given by the UICC. The terminal should not modify the display corresponding to the initial user request;
 - if the alpha identifier is not provided by the UICC, the terminal may indicate to the user that the initial user request has been changed;
- if the UICC responds with "allowed, with modifications" to a user-initiated request (i.e. a request not initiated by a proactive command), and the modified user request is beyond the terminal's capabilities, then the terminal may give information to the user on the modified request and the fact that the modified request is beyond the terminal's capabilities, optionally using the alpha identifier, if one is provided by the UICC;
- if the UICC responds with "allowed, with modifications" to a request by a proactive command SET UP CALL, and the modified request is beyond the terminal's capabilities, then the terminal shall not give any information to the user on the fact that the modified request is beyond the terminal's capabilities, and shall give a TERMINAL RESPONSE to the proactive command (i.e. SET UP CALL) as detailed in clause 7.3.1.1. The responsibility to inform the user in this case lies with the UICC application which sent the proactive command.

7.3.1.4 Interaction with Fixed Dialling Number (FDN)

It is permissible for the Fixed Dialling Number (FDN) service to be enabled at the same time as Call Control is available in the NAA Service Table.

If FDN is enabled and Call Control is activated, the terminal shall follow this procedure:

- the terminal shall check that the number entered through the MMI is on the FDN list;
- if the MMI input does not pass the FDN check, the call shall not be set-up;
- if the MMI input does pass the FDN check, the terminal shall pass the dialled digits and other parameters to the UICC, using the ENVELOPE (CALL CONTROL) command;
- if the UICC responds with "allowed, no modification", the terminal shall set up the call as proposed;
- if the UICC responds with "not allowed", the terminal shall not set up the call;
- if the UICC responds with "allowed with modifications", the terminal shall set up the call in accordance with the response from the UICC. If the modifications involve changing the dialled digits, the terminal shall not re-check this modified number (or string) against the FDN list.

If the user wishes to enable or disable Fixed Dialling Number, the terminal shall follow the procedure defined in the relevant access technology specification. The state of the Call Control service shall have no effect on this procedure.

7.3.1.5 Support of Barred Dialling Number (BDN) service

The BDN service shall be allocated and activated in the NAA Service Table only if Call Control is also available in the NAA Service Table.

If Barred Dialling Number service is enabled, when receiving the dialled number and other parameters from the terminal, the NAA may check this information against those stored in EF_{BDN} (examples of comparison methods are given in TS 100 906 (see bibliography):

- if the UICC responds with "not allowed" (e.g. a match is made against a BDN), the terminal shall not set up the call;
- if the UICC responds with "allowed, no modification", the terminal shall set up the call as proposed;
- if the UICC responds with "allowed with modifications", the terminal shall set up the call in accordance with the response from the UICC. If the modifications involve changing the dialled number, the terminal shall not re-check this modified number (or string) against the FDN list when FDN is enabled.

If the user wishes to enable or disable Barred Dialling Number, the terminal shall follow the procedure defined in the relevant access technology specification.

7.3.1.6 Structure of ENVELOPE (CALL CONTROL)

Direction: terminal to UICC.

The command header is specified in TS 102 221 [1] for a 3G platform and in TS 151 011 [8] for a 2G platform.

Command parameters/data.

Description	Clause	M/O/C	Min	Length
Call control tag	9.1	M	Y	1
Length (A+B+C+D+E+F)	-	M	Y	1 or 2
Device identities	8.7	M	Y	A
Address	8.1	M	Y	B
Capability configuration parameters 1	8.4	O	N	C
Subaddress	8.3	O	N	D
Location information	8.19	M	N	E
Capability configuration parameters 2	8.4	O	N	F

Device identities: the terminal shall set the device identities to:

- source: terminal;
- destination: UICC.

Address: only one data object shall be sent to the UICC:

- for a call set-up, the address data object is used and holds the Called Party Number, to which the terminal is proposing setting up the call;

Capability configuration parameters: only used for a call set-up, this contains the Bearer capabilities that the terminal is proposing to send to the network. The first capability configuration parameters correspond to the bearer capability 1 information element of a mobile originating call setup message. The second capability configuration parameters correspond to the bearer capability 2 information element of a mobile originating call setup message. If no capability configuration parameters are present, this shall indicate a speech call.

Subaddress: only used for a call set-up, this contains the called party subaddress that the terminal is proposing to send to the network. If one is not present, this shall indicate that the terminal is proposing not to send this information element to the network.

Location information: this data object contains the identification of the current serving cell of the terminal. The comprehension required flag of this data object in this command shall be set to '0'.

Response parameters/data.

It is permissible for the UICC to provide no response data, by responding with SW1/SW2 = '90 00'. If the UICC does not provide any response data, then this shall have the same meaning as "allowed, no modification".

Description	Clause	M/O/C	Min	Length
Call control result	-	M	Y	1
Length (A+B+C+D+E+F)	-	M	Y	1 or 2
Address	8.1	O	N	A
Capability configuration parameters 1	8.4	O	N	B
Subaddress	8.3	O	N	C
Alpha identifier	8.2	O	N	D
BC repeat indicator	8.42	C	N	E
Capability configuration parameters 2	8.4	O	N	F

Call control result:

- Contents: the command that the UICC gives to the terminal concerning whether to allow, bar or modify the proposed call;
- Coding:
 - '00' = Allowed, no modification;
 - '01' = Not allowed;
 - '02' = Allowed with modifications.

Address: only one data object may be included if the UICC requests the call details to be modified:

- for a call set-up, if the address data object is not present, then the terminal shall assume the Dialling number is not to be modified.

Capability configuration parameters: only used for a call set-up, this data object is only required if the NAA application requests the call details to be modified. The first capability configuration parameters corresponds to the bearer capability 1 information element of a mobile originating call setup message. The second capability configuration parameters corresponds to the bearer capability 2 information element of a mobile originating call setup message. If the capability configuration parameters are not present, then the terminal shall assume the parameters are not to be modified.

Subaddress: only used for a call set-up, this data object is only required if the NAA application requests the call details to be modified. If the subaddress is not present, then the terminal shall assume the called party subaddress is not to be modified. If the subaddress supplied by the NAA application is a null data object, then the terminal shall not provide a called party subaddress to the network. A null data object shall have length = '00' and no value part.

Alpha identifier: this data object is only required if the UICC requests a particular indication to be given to the user. The handling of this data object by the terminal is described in clause 7.3.1.3. The comprehension required flag of this data object shall be set to '0'.

BC repeat indicator: indicates how the 2 associated bearers shall be interpreted. This BC repeat indicator is conditioned to the presence of the second capability configuration parameters.

It is mandatory for the UICC to provide at least one of the optional data objects if it has set the Call control result to "allowed with modifications".

NOTE: The technology specific toolkit specification will define the appropriate call setup message.

7.4 Timer expiration

7.4.1 Description

When a timer previously started by a **TIMER MANAGEMENT** proactive command expires, the terminal shall pass the identifier of the timer that has expired and its value using the **ENVELOPE (TIMER EXPIRATION)** command, as defined in clause 7.4.2.

If the UICC is busy and returns status '93 00', the terminal shall retry until the command is accepted.

NOTE: In order to avoid retrying periodically, the terminal could retry after a **TERMINAL RESPONSE** processed by the UICC with status '90 00'.

7.4.2 Structure of ENVELOPE (TIMER EXPIRATION)

Direction: terminal to UICC.

The command header is specified in TS 102 221 [1] for a 3G platform and in TS 151 011 [8] for a 2G platform.

Command parameters/data.

Description	Clause	M/O/C	Min	Length
Timer Expiration tag	9.1	M	Y	1
Length (A+B+C)	-	M	Y	1 or 2
Device identities	8.7	M	Y	A
Timer identifier	8.37	M	Y	B
Timer value	8.38	M	Y	C

Device identities: the terminal shall set the device identities to:

- source: terminal;
- destination: UICC.

Timer identifier: identifier of the timer that has expired.

Timer value: difference between the time when this command is issued and the time when the timer was initially started. This should be as close as possible to the value of the timer given in the initial **TIMER MANAGEMENT** command.

Response parameters/data:

- none.

7.5 Event download

A set of events for the terminal to monitor can be supplied by the UICC using the proactive command **SET UP EVENT LIST**. If the UICC has sent this command, and an event which is part of the list subsequently occurs, the terminal informs the UICC using the procedure below, relevant for that event.

Processing within the terminal resulting from this event shall proceed as normal, independent of sending the **ENVELOPE** command to the UICC.

Where events occur while the UICC-terminal interface is already busy, the terminal shall queue events and send event download messages to the UICC in the order in which they occurred.

Where events occur and the UICC responds with '93 00', the ME shall retry to deliver the event download messages to the SIM.

7.5.1 MT call event

7.5.1.1 Procedure

If the MT call event is part of the current event list (as set up by the last SET UP EVENT LIST command, see clause 6.4.16), then when the terminal receives an incoming call setup message, the terminal shall inform the UICC that this has occurred, by using the ENVELOPE (EVENT DOWNLOAD - MT call) command as defined in clause 7.5.1.2.

NOTE: The technology specific toolkit specification will define the appropriate call setup message.

7.5.1.2 Structure of ENVELOPE (EVENT DOWNLOAD - MT call)

Direction: terminal to UICC.

The command header is specified in TS 102 221 [1] for a 3G platform and in TS 151 011 [8] for a 2G platform.

Command parameters/data.

Description	Clause	M/O/C	Min	Length
Event download tag	9.1	M	Y	1
Length (A+B+C+D+E)	-	M	Y	1 or 2
Event list	8.25	M	Y	A
Device identities	8.7	M	Y	B
Transaction identifier	8.28	M	Y	C
Address	8.1	C	N	D
Subaddress	8.3	C	N	E

Event list: the event list object shall contain only one event (value part of length 1 byte), and terminal shall set the event to:

- MT call.

Device identities: the terminal shall set the device identities to:

- source: network;
- destination: UICC.

Transaction identifier: the transaction identifier data object shall contain one transaction identifier, and this shall be the Transaction Identifier in the call setup message from the network.

Address: the address data object holds the Calling Party number received by the terminal in the call setup message. If the Calling Party number is included in the call setup message, the terminal shall include the Address object, otherwise the terminal shall not include the Address object.

Subaddress: The Subaddress data object holds the Calling Party Subaddress as received by the terminal in the call setup message. If the Calling Party Subaddress is included in the call setup message, the terminal shall include the Subaddress object, otherwise the terminal shall not include the Subaddress object.

Response parameters/data:

- none.

7.5.2 Call connected event

7.5.2.1 Procedure

If the call connected event is part of the current event list (as set up by the last SET UP EVENT LIST command, see clause 6.4.16), then when the terminal receives an incoming call connect message (in the case of an MO call), or when the terminal sends an outgoing call connect message (in the case of an MT call), the terminal shall inform the UICC that this has occurred, by using the ENVELOPE (EVENT DOWNLOAD - call connected) command as defined in clause 7.5.2.2.

In the case of a call initiated through a SET UP CALL proactive command while the call connected event is part of the current event list, the terminal shall send both the TERMINAL RESPONSE related to the proactive command, and the EVENT DOWNLOAD command, in the order TERMINAL RESPONSE first, ENVELOPE (EVENT DOWNLOAD - call connected) second.

NOTE: The technology specific toolkit specification will define the appropriate call connect message.

7.5.2.2 Structure of ENVELOPE (EVENT DOWNLOAD - Call connected)

Direction: terminal to UICC.

The command header is specified in TS 102 221 [1] for a 3G platform and in TS 151 011 [8] for a 2G platform.

Command parameters/data.

Description	Clause	M/O/C	Min	Length
Event download tag	9.1	M	Y	1
Length (A+B+C)	-	M	Y	1 or 2
Event list	8.25	M	Y	A
Device identities	8.7	M	Y	B
Transaction identifier	8.28	M	Y	C

Event list: the event list object shall contain only one event (value part of length 1 byte), and terminal shall set the event to:

- call connected.

Device identities:

- in the case of connecting at the near end (an MT call), the terminal shall set the device identities to:
 - source: terminal;
 - destination: UICC.
- in the case of connecting at the far end (an MO call), the terminal shall set the device identities to:
 - source: network;
 - destination: UICC.

Transaction identifier: the transaction identifier data object shall contain one transaction identifier, and this shall be the Transaction Identifier in the call connect message.

Response parameters/data:

- none.

7.5.3 Call disconnected event

7.5.3.1 Procedure

If the call disconnected event is part of the current event list (as set up by the last SET UP EVENT LIST command, see clause 6.4.16), while the terminal is not in the NULL state (i.e. has sent or received a call setup message) and the call is disconnected, the terminal shall inform the UICC that this has occurred by using the ENVELOPE (EVENT DOWNLOAD - call disconnected) command as defined in clause 7.5.3.2. This can happen as the result of the terminal sending or receiving one or more disconnect messages, or as the result of a radio link failure; if more than one of these occur within the same call, the ENVELOPE command shall be sent on the first occurrence.

If the terminal initiates the disconnection, or in the case of radio link failure, this is considered a "near end" disconnection, whereas a "far end" disconnection is defined as when the network initiates the disconnection. The terminal shall set the Device Identities accordingly.

NOTE: The technology specific toolkit specification will define the appropriate disconnect messages.

7.5.3.2 Structure of ENVELOPE (EVENT DOWNLOAD - Call disconnected)

Direction: terminal to UICC.

The command header is specified in TS 102 221 [1] for a 3G platform and in TS 151 011 [8] for a 2G platform.

Command parameters/data.

Description	Clause	M/O/C	Min	Length
Event download tag	9.1	M	Y	1
Length (A+B+C+D)	-	M	Y	1 or 2
Event list	8.25	M	Y	A
Device identities	8.7	M	Y	B
Transaction identifier	8.28	M	Y	C
Cause	8.26	O	N	D

Event list: the event list object shall contain only one event (value part of length 1 byte), and terminal shall set the event to:

- call disconnected.

Device identities:

- in the case of "near end" disconnection, the terminal shall set the device identities to:
 - source: terminal;
 - destination: UICC.
- in the case of "far end" disconnection, the terminal shall set the device identities to:
 - source: network;
 - destination: UICC.

Transaction identifier: the transaction identifier data object shall contain a list of the transaction identifiers for each of the calls being disconnected.

Cause: the cause shall reflect the cause information element sent or received in the disconnect message triggering the ENVELOPE command. If the cause information element was not present in the message, or the cause data object shall not be included. In the case of a radio link timeout, the cause data object shall be included, with a value part of zero length.

Response parameters/data:

- none.

7.5.4 Location status event

7.5.4.1 Procedure

If the location status event is part of the current event list (as set up by the last SET UP EVENT LIST command, see clause 6.4.16), then when the terminal enters the idle state with the result that either the Location status or Location information has been changed or updated, the terminal shall inform the UICC that this has occurred, by using the ENVELOPE (EVENT DOWNLOAD - location status) command as defined in clause 7.5.4.2.

NOTE: The technology specific toolkit specification will define the appropriate idle state for change of location purposes.

7.5.4.2 Structure of ENVELOPE (EVENT DOWNLOAD - Location status)

Direction: terminal to UICC.

The command header is specified in TS 102 221 [1] for a 3G platform and in TS 151 011 [8] for a 2G platform.

Command parameters/data.

Description	Clause	M/O/C	Min	Length
Event download tag	9.1	M	Y	1
Length (A+B+C+D)	-	M	Y	1 or 2
Event list	8.25	M	Y	A
Device identities	8.7	M	Y	B
Location status	8.27	M	Y	C
Location information	8.19	C	N	D

Event list: the event list object shall contain only one event (value part of length 1 byte), and terminal shall set the event to:

- location status.

Device identities: the terminal shall set the device identities to:

- source: terminal;
- destination: UICC.

Location status: this object shall contain the current service state of the terminal.

Location information: this object shall only be included if the Location status object indicates Normal Service. This object shall contain the details of the network, location area and cell that have been selected.

Response parameters/data:

- none.

7.5.5 User activity event

7.5.5.1 Procedure

If the user activity event is part of the current event list (as set up by the last SET UP EVENT LIST command, see clause 6.4.16), then the terminal shall follow the procedure below:

- when the terminal next detects some user activity (e.g. a key-press, removal of key-lock), the terminal shall inform the UICC that this has occurred, by using the ENVELOPE (EVENT DOWNLOAD - user activity) command as defined in clause 7.5.2.2;
- as a result of sending this command to the UICC, the terminal shall remove the user activity event from its current event list. This is in order for the terminal to report this event only once after the event has been requested by the UICC.

7.5.5.2 Structure of ENVELOPE (EVENT DOWNLOAD - User activity)

Direction: terminal to UICC.

The command header is specified in TS 102 221 [1] for a 3G platform and in TS 151 011 [8] for a 2G platform.

Command parameters/data.

Description	Clause	M/O/C	Min	Length
Event download tag	9.1	M	Y	1
Length (A+B)	-	M	Y	1 or 2
Event list	8.25	M	Y	A
Device identities	8.7	M	Y	B

Event list: the event list object shall contain only one event (value part of length 1 byte), and terminal shall set the event to:

- user activity.

Device identities: the terminal shall set the device identities to:

- source: terminal;
- destination: UICC.

Response parameters/data:

- none.

7.5.6 Idle screen available event

7.5.6.1 Procedure

If the idle screen available event is part of the current event list (as set up by the last SET UP EVENT LIST command, see clause 6.4.16), then the terminal shall follow the procedure below:

- when the terminal next enters a state where it would accept rather than reject a DISPLAY TEXT command of normal priority, the terminal shall inform the UICC that this has occurred, by using the ENVELOPE (EVENT DOWNLOAD - idle screen available) command as defined in clause 7.5.6.2;
- as a result of sending this command to the UICC, the terminal shall remove the idle screen available event from its current event list. This is in order for the terminal to report this event only once after the event has been requested by the UICC.

7.5.6.2 Structure of ENVELOPE (EVENT DOWNLOAD - Idle screen available)

Direction: terminal to UICC.

The command header is specified in TS 102 221 [1] for a 3G platform and in TS 151 011 [8] for a 2G platform.

Command parameters/data.

Description	Clause	M/O/C	Min	Length
Event download tag	9.1	M	Y	1
Length (A+B)	-	M	Y	1 or 2
Event list	8.25	M	Y	A
Device identities	8.7	M	Y	B

Event list: the event list object shall contain only one event (value part of length 1 byte), and terminal shall set the event to:

- idle screen available.

Device identities: the terminal shall set the device identities to:

- source: display;
- destination: UICC.

Response parameters/data:

- none.

7.5.7 Card reader status event

The following clauses under clause 7.5.7 apply if class "a" is supported.

7.5.7.1 Procedure

If the card reader status event is part of the current event list (as set up by the last SET UP EVENT LIST command, see clause 6.4.16), then when the terminal detects one of the following changes:

- a card reader becomes available or unavailable (e.g. a removable card reader is attached); or
- a card is inserted or removed.

The terminal shall inform the UICC that this has occurred, by using the ENVELOPE (EVENT DOWNLOAD - card reader status) command as defined in clause 7.5.7.2.

7.5.7.2 Structure of ENVELOPE (EVENT DOWNLOAD - Card reader status)

Direction: terminal to UICC.

The command header is specified in TS 102 221 [1] for a 3G platform and in TS 151 011 [8] for a 2G platform.

Command parameters/data.

Description	Clause	M/O/C	Min	Length
Event download tag	9.1	M	Y	1
Length (A+B+C)	-	M	Y	1 or 2
Event list	8.25	M	Y	A
Device identities	8.7	M	Y	B
Card reader status	8.33	M	Y	C

Event list: the event list object shall contain only one event (value part of length 1 byte), and terminal shall set the event to:

- card reader status.

Device identities: the terminal shall set the device identities to:

- source: terminal;
- destination: UICC.

Card reader status: the card reader status data object shall contain the identifier and status flags for the card reader that has generated the event.

Response parameters/data: None for this type of ENVELOPE command.

7.5.8 Language selection event

7.5.8.1 Procedure

If the language selection event is part of the event list (as set up by the last SET UP EVENT LIST command, see clause 6.4.16), then when the terminal changes the currently used language, the terminal shall inform the UICC that this has occurred, by using the ENVELOPE (EVENT DOWNLOAD - language selection) command as defined in clause 7.5.8.2.

7.5.8.2 Structure of ENVELOPE (EVENT DOWNLOAD - Language selection)

Direction: terminal to UICC.

The command header is specified in TS 102 221 [1] for a 3G platform and in TS 151 011 [8] for a 2G platform.

Command parameters/data.

Description	Clause	M/O/C	Min	Length
Event download tag	9.1	M	Y	1
Length (A+B+C)	-	M	Y	1 or 2
Event list	8.25	M	Y	A
Device identities	8.7	M	Y	B
Language	8.45	M	Y	C

Event list: the event list object shall contain only one event (value part of length 1 byte), and terminal shall set the event to:

- language selection.

Device identities: the terminal shall set the device identities to:

- source: terminal;
- destination: UICC.

Language: This object shall contain the currently used language of the terminal.

Response parameters/data: None for this type of ENVELOPE command.

7.5.9 Browser termination event

7.5.9.1 Procedure

If the browser termination event is part of the event list (as set up by the last SET UP EVENT LIST command, see clause 6.4.16), then when the browser is terminated either by the user action or by an error, the terminal shall inform the UICC that this has occurred, by using the ENVELOPE (EVENT DOWNLOAD - browser termination) command as defined in clause 7.5.9.2.

7.5.9.2 Structure of ENVELOPE (EVENT DOWNLOAD - Browser termination)

Direction: terminal to UICC.

The command header is specified in TS 102 221 [1] for a 3G platform and in TS 151 011 [8] for a 2G platform.

Command parameters/data.

Description	Clause	M/O	Min	Length
Event download tag	9.1	M	Y	1
Length (A+B+C)	-	M	Y	1 or 2
Event list	8.25	M	Y	A
Device identities	8.7	M	Y	B
Browser termination cause	8.51	M	Y	C

Event list: the event list object shall contain only one event (value part of length 1 byte), and terminal shall set the event to:

- browser termination.

Device identities: the terminal shall set the device identities to:

- source: terminal;
- destination: UICC.

Browser termination cause: This object shall contain the browser termination cause.

Response parameters/data: None for this type of ENVELOPE command.

7.5.10 Data available event

The following clauses apply if class "e" is supported.

7.5.10.1 Procedure

If the Data available event is part of the current event list (as set up by the last SET UP EVENT LIST command, see clause 6.4.16), then, only if the targeted channel buffer is empty when new data arrives in it, the terminal shall inform the UICC that this has occurred, by using the ENVELOPE (EVENT DOWNLOAD - Data available) command as defined in clause 7.5.10.2.

7.5.10.2 Structure of ENVELOPE (EVENT DOWNLOAD - Data available)

Direction: terminal to UICC.

The command header is specified in TS 102 221 [1] for a 3G platform and in TS 151 011 [8] for a 2G platform.

Command parameters/data.

Description	Clause	M/O	Min	Length
Event download tag	9.1	M	Y	1
Length (A+B+C+D)	-	M	Y	1 or 2
Event list	8.25	M	Y	A
Device identities	8.7	M	Y	B
Channel status	8.56	M	Y	C
Channel data length	8.54	M	Y	D

Event list: the Event list data object shall contain only one event (value part of length 1 byte), and terminal shall set the event to:

- data available.

Device identities: the terminal shall set the device identities to:

- source: terminal;
- destination: UICC.

Channel status: this data object shall contain the status and identifier of the channel on which the event occurred.

Channel data length: this data object shall contain the number of bytes received, e.g. available in the channel buffer. If more than 255 bytes are available, 'FF' is used.

Response parameters/data: None for this type of ENVELOPE command.

7.5.11 Channel status event

The following clauses apply if class "e" is supported.

7.5.11.1 Procedure

If the Channel status event is part of the current event list (as set up by the last SET UP EVENT LIST command, see clause 6.4.16), then, when the terminal detects one of the following changes:

- a link enters an error condition; or
- any other error,

which is not resulting from the execution of a proactive command, the terminal shall inform the UICC that this has occurred, by using the ENVELOPE (EVENT DOWNLOAD - Channel status) command as defined in clause 7.5.11.2.

The channel identifier for a data channel shall not be released during a card session until the CLOSE CHANNEL command for this channel identifier has been successfully executed.

The terminal shall not empty the Rx/Tx buffers during the card session until the CLOSE CHANNEL command has been successfully executed.

7.5.11.2 Structure of ENVELOPE (EVENT DOWNLOAD - Channel status)

Direction: terminal to UICC.

The command header is specified in TS 102 221 [1] for a 3G platform and in TS 151 011 [8] for a 2G platform.

Command parameters/data.

Description	Clause	M/O	Min	Length
Event download tag	9.1	M	Y	1
Length (A+B+C)	-	M	Y	1 or 2
Event list	8.25	M	Y	A
Device identities	8.7	M	Y	B
Channel status	8.56	M	Y	C

Event list: the Event list data object shall contain only one event (value part of length 1 byte), and terminal shall set the event to:

- channel status.

Device identities: the terminal shall set the device identities to:

- source: terminal;
- destination: UICC.

Channel status: this data object shall contain the status and identifier of the channel on which the event occurred.

Response parameters/data: None for this type of ENVELOPE command.

7.5.12 Access technology change event

7.5.12.1 Procedure

If the Access Technology Change event is part of the current event list (as set up by the last SET UP EVENT LIST command, see clause 6.4.16), then, when the terminal detects a change in its current access technology the terminal shall inform the UICC that this has occurred, by using the ENVELOPE (EVENT DOWNLOAD - Access Technology Change) command as defined in clause 7.5.12.2.

7.5.12.2 Structure of ENVELOPE (EVENT DOWNLOAD - Access Technology Change)

Direction: terminal to UICC.

The command header is specified in TS 102 221 [1] for a 3G platform and in TS 151 011 [8] for a 2G platform.

Command parameters/data.

Description	Clause	M/O	Min	Length
Event download tag	9.1	M	Y	1
Length (A+B+C)	-	M	Y	1 or 2
Event list	8.25	M	Y	A
Device identities	8.7	M	Y	B
Access Technology	8.61	M	Y	C

Event list: the Event list data object shall contain only one event (value part of length 1 byte), and terminal shall set the event to:

- Access Technology Change.

Device identities: the terminal shall set the device identities to:

- source: terminal;
- destination: UICC.

Access Technology: this data object shall contain the current access technology that the terminal is using

Response parameters/data: None for this type of ENVELOPE command.

7.5.13 Display parameters changed event

7.5.13.1 Procedure

If the display parameters changed event is part of the current event list (as set up by the last SET UP EVENT LIST command, see clause 6.4.16), then when the screen of the terminal is resized, the terminal shall inform the UICC that this has occurred, by using the ENVELOPE (EVENT DOWNLOAD - Display parameters changed) command as defined in clause 7.5.13.1.

7.5.13.2 Structure of ENVELOPE (EVENT DOWNLOAD - Display parameters changed)

Direction: terminal to UICC.

The command header is specified in TS 102 221 [1] for a 3G platform and in TS 151 011 [8] for a 2G platform.

Command parameters/data.

Description	Clause	M/O	Min	Length
Event download tag	9.1	M	Y	1
Length (A+B+C)	-	M	Y	1 or 2
Event list	8.25	M	Y	A
Device identities	8.7	M	Y	B
Display Parameters	8.62	M	Y	C

Event list: the Event list data object shall contain only one event (value part of length 1 byte), and terminal shall set the event to:

- display parameters changed.

Device identities: the terminal shall set the device identities to:

- source: terminal;
- destination: UICC.

Display parameters changed: this data object shall contain the current terminal's screen parameters.

Response parameters/data: None for this type of ENVELOPE command.

7.5.14 Local connection event

7.5.14.1 Procedure

If the Local Connection event is part of the current event list (as set up by the last SET UP EVENT LIST command, see clause 6.4.16), then when the terminal receives an incoming connection request on a local bearer using a service previously declared by the UICC, the terminal shall inform the UICC that it has occurred, by using the ENVELOPE (EVENT DOWNLOAD - Local Connection) command as defined in clause 7.5.14.2. The terminal shall then wait for an OPEN CHANNEL with the parameters given in the event before proceeding with the local connection establishment.

7.5.14.2 Structure of ENVELOPE (EVENT DOWNLOAD - Local Connection)

Direction: terminal to UICC.

The command header is specified in TS 102 221 [1].

Command parameters/data.

Description	Clause	M/O/C	Min	Length
Event download tag	9.1	M	Y	1
Length (A+B+C+D)	-	M	Y	1 or 2
Event list	8.25	M	Y	A
Device identities	8.7	M	Y	B
Service Record	8.63	M	Y	D
Remote Entity Address	8.68	O	N	C

Event list: the event list object shall contain only one event (value part of length 1 byte), and terminal shall set the event to:

- Local connection.

Device identities: the terminal shall set the device identities to:

- source: Network;
- destination: UICC.

Service Record: this data object shall contain the service record of the service being connected by a remote device. If the terminal provides a Service Record different from '00', the UICC shall ignore it.

Response parameters/data: none.

8 SIMPLE-TLV data objects

This clause specifies the coding of the SIMPLE-TLV data objects, which are contained in a BER-TLV data object. SIMPLE-TLV data objects may be transferred across the interface in either direction. A SIMPLE-TLV data object consists of a tag of length one byte, a length indicator, which gives the number of bytes in the value field, and a value part of variable length, whose contents, meaning and coding are given below.

Tag codings are given in clause 9.3 for all SIMPLE-TLV data objects.

'00' and 'FF' are never used as tag values for SIMPLE-TLVs. This is in alignment with ISO/IEC 7816-6 [15]. Padding characters are not allowed.

For some of the SIMPLE-TLV data objects described, the length field shall be coded on 1 or 2 bytes (Y value) according to annex C, depending on the value of byte 1.

All bits and bytes indicated as RFU within all SIMPLE-TLV data objects shall be respectively set to 0 and '00' by the sending entity.

The handling of reserved values and RFU bits or bytes within all SIMPLE-TLV data objects at the receiving entity is described in clause 6.10.

8.1 Address

Byte(s)	Description	Length
1	Address tag	1
2 to (Y-1)+2	Length (X)	Y
(Y-1)+3	TON and NPI	1
(Y-1)+4 to (Y-1)+X+2	Dialling number string	X-1

TON/NPI:

- Contents:
 - Type Of Number (TON) and Numbering Plan Identification (NPI).
- Coding:
 - It is coded as defined for EF_{ADN} in TS 131 102 [6], the format of the byte is as follows:

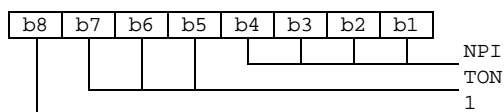

TON values:

- Coding:
 - 000: Unknown;
 - 001: International Number;
 - 010: National Number;
 - 011: Network Specific Number;
 - other values are reserved or access technology specific.

NPI values:

- Coding:
 - 0000: Unknown;
 - 0001: ISDN/telephony numbering plan (ITU-T Recommendations E.164 [22] and E.163 (see bibliography));
 - 0011: Data numbering plan (ITU-T recommendation X.121 [23]);
 - 0100: Telex numbering plan (ITU-T Recommendation F.69 [24]);
 - 1001: Private numbering plan;
 - 1111: Reserved for extension;
 - other values are reserved or access technology specific.

Dialling number string:

- Coding:
 - coded as for EF_{ADN} , and may include DTMF separators and DTMF digits, which the terminal shall send in the same way as for EF_{ADN} but without locally generating audible DTMF tones to the user;
 - see TS 131 102 [6] for the coding of EF_{ADN} .

8.2 Alpha identifier

Byte(s)	Description	Length
1	Alpha identifier tag	1
2 to (Y-1)+2	Length (X)	Y1
(Y-1)+3 to (Y-1)+X+2	Alpha identifier	X

- Coding:
 - the alpha identifier is coded as for EF_{ADN} ;
 - see TS 131 102 [6] for the coding of EF_{ADN} .

8.3 Subaddress

Byte(s)	Description	Length
1	Subaddress tag	1
2 to (Y-1)+2	Length (X)	Y
(Y-1)+3 to (Y-1)+X+2	Subaddress	X

Subaddress contains information as for EF_{ADN}. See TS 131 102 [6] for the coding of. All information defined in TS 131 102 [6] shall be given in the value part of the data object, except the length of subaddress contents (which is given here by the length part of the data object).

8.4 Capability configuration parameters

Byte(s)	Description	Length
1	Capability configuration parameters tag	1
2 to (Y-1)+2	Length (X)	Y
(Y-1)+3 to (Y-1)+X+2	Capability configuration parameters	X

Capability configuration parameters coding is defined by the different access technologies.

8.5 Void

8.6 Command details

Byte(s)	Description	Length
1	Command details tag	1
2	Length = '03'	1
3	Command number	1
4	Type of command	1
5	Command Qualifier	1

Command number:

- Contents and coding: see clause 6.5.1.

Type of command:

- Contents:
 - the Type of Command specifies the required interpretation of the data objects which follow, and the required terminal procedure;
- Coding:
 - see clause 9.4;
 - the terminal shall respond to reserved values (i.e. values not listed) with the result "Command type not understood".

Command Qualifier:

- Contents: qualifiers specific to the command;

- Coding:
 - REFRESH:
 - '00' = NAA Initialization and Full File Change Notification;
 - '01' = File Change Notification;
 - '02' = NAA Initialization and File Change Notification;
 - '03' = NAA Initialization;
 - '04' = UICC Reset;
 - '05' = NAA Application Reset, only applicable for a 3G platform;
 - '06' = NAA Session Reset, only applicable for a 3G platform;
 - '07' to 'FF' = reserved values.
 - MORE TIME: this byte is RFU.
 - POLL INTERVAL: this byte is RFU.
 - POLLING OFF: this byte is RFU.
 - SET UP CALL:
 - '00' = set up call, but only if not currently busy on another call;
 - '01' = set up call, but only if not currently busy on another call, with redial;
 - '02' = set up call, putting all other calls (if any) on hold;
 - '03' = set up call, putting all other calls (if any) on hold, with redial;
 - '04' = set up call, disconnecting all other calls (if any);
 - '05' = set up call, disconnecting all other calls (if any), with redial;
 - '06' to 'FF' = reserved values.
 - SEND DTMF: this byte is RFU.
 - SEND SHORT MESSAGE:
 - bit 1: 0 = packing not required;
 1 = SMS packing by the ME required.
 - bits 2-8: = 0 RFU.
 - SET UP EVENT LIST: this byte is RFU.
 - PLAY TONE: this byte is RFU.
 - DISPLAY TEXT:
 - bit 1: 0 = normal priority;
 1 = high priority.
 - bits 2 to 7: = RFU.
 - bit 8: 0 = clear message after a delay;
 1 = wait for user to clear message.

- GET INKEY:
 - bit 1: 0 = digits (0-9, *, # and +) only;
1 = alphabet set.
 - bit 2: 0 = SMS default alphabet;
1 = UCS2 alphabet.
 - bit 3: 0 = character sets defined by bit 1 and bit 2 are enabled;
1 = character sets defined by bit 1 and bit 2 are disabled and the "Yes/No" response is requested.
 - bit 4: 0 = user response shall be displayed. The terminal may allow alteration and/or confirmation;
1 = an immediate digit response (0-9, * and #) is requested.
 - bits 5 to 7: = RFU.
 - bit 8: 0 = no help information available;
1 = help information available.
- GET INPUT:
 - bit 1: 0 = digits (0-9, *, #, and +) only;
1 = alphabet set.
 - bit 2: 0 = SMS default alphabet;
1 = UCS2 alphabet.
 - bit 3: 0 = terminal may echo user input on the display;
1 = user input shall not be revealed in any way (see note).
 - bit 4: 0 = user input to be in unpacked format;
1 = user input to be in SMS packed format.
 - bits 5 to 7: = RFU.
 - bit 8: 0 = no help information available;
1 = help information available.

NOTE: Where user input is not to be revealed, the terminal may provide an indication of key entries, such as by displaying "*" s. See clause 6.4.3 for more information on the character set available in this mode.

- SELECT ITEM:
 - bit 1: 0 = presentation type is not specified;
1 = presentation type is specified in bit 2.
 - bit 2: 0 = presentation as a choice of data values if bit 1 = '1';
1 = presentation as a choice of navigation options if bit 1 is '1'.
 - bit 3: 0 = no selection preference;
1 = selection using soft key preferred.
 - bits 4 to 7: = RFU.

- bit 8: 0 = no help information available;
1 = help information available.
- SET UP MENU:
 - bit 1: 0 = no selection preference;
1 = selection using soft key preferred.
 - bits 2 to 7: = RFU.
 - bit 8: 0 = no help information available;
1 = help information available.
- PROVIDE LOCAL INFORMATION:
 - '00' = Location Information according to current NAA;
 - '01' = IMEI of the terminal;
 - '02' = Network Measurement results according to current NAA;
 - '03' = Date, time and time zone;
 - '04' = Language setting;
 - '05' = Reserved for GSM;
 - '06' = Access Technology;
 - '07' = ESN of the terminal;
 - '08' to 'FF' = Reserved.
- SET UP IDLE MODE TEXT: this byte is RFU.
- PERFORM CARD APDU: this byte is RFU.
- POWER OFF CARD: this byte is RFU.
- POWER ON CARD: this byte is RFU.
- GET READER STATUS:
 - '00' = Card reader status;
 - '01' = Card reader identifier;
 - '02' to 'FF' = Reserved.
- TIMER MANAGEMENT:
 - bits 1 to 2: 00 = start;
01 = deactivate;
10 = get current value;
11 = RFU.
 - bits 3 to 8: RFU.
- RUN AT COMMAND: this byte is RFU.

- LANGUAGE NOTIFICATION:
 - bit 1: 0 = non-specific language notification;
1 = specific language notification.
 - bits 2 to 8: = RFU.
- LAUNCH BROWSER:
 - '00' = launch browser if not already launched;
 - '01' = not used;
 - '02' = use the existing browser (the browser shall not use the active existing secured session);
 - '03' = close the existing browser session and launch new browser session;
 - '04' = not used;
 - '05' to 'FF' = RFU.
- OPEN CHANNEL:
 - bit 1: 0 = on demand link establishment;
1 = immediate link establishment.
 - bit 2: 0 = no automatic reconnection;
1 = automatic reconnection.
 - bits 3 to 8: = RFU.
- CLOSE CHANNEL: this byte is RFU.
- RECEIVE DATA: this byte is RFU.
- SEND DATA:
 - bit 1: 0 = store data in Tx buffer;
1 = send data immediately.
 - bits 2 to 8: = RFU.
- GET CHANNEL STATUS: this byte is RFU.
- SERVICE SEARCH (if class "f" is supported): this byte is RFU.
- GET SERVICE INFORMATION (if class "f" is supported): this byte is RFU.
- DECLARE SERVICE (if class "f" is supported):
 - bit 1: 0 = add a new service to the terminal service database;
1 = delete a service from the terminal service database.
 - bit 2 to 8: = RFU

The terminal shall respond to reserved values with the result "Command type not understood".

8.7 Device identities

Byte(s)	Description	Length
1	Device identities tag	1
2	Length = '02'	1
3	Source device identity	1
4	Destination device identity	1

Source device identity:

- Contents: the source device for information held in the data objects which follow.

Destination device identity:

- Contents: the destination device for information held in the data objects which follow.

NOTE: Only some combinations of Type of Command, Data Download type and Device identities are allowed. These are defined in clause 10.

- Coding:
 - both Source and Destination device identities are coded as follows:
 - '01' = Keypad;
 - '02' = Display;
 - '03' = Earpiece;
 - '10' to '17' = Additional Card Reader x (0 to 7). Value assigned by terminal;
 - '21' to '27' = Channel x (1 to 7). Value assigned by terminal;
 - '81' = UICC;
 - '82' = terminal;
 - '83' = network;
 - All other values are reserved.

8.8 Duration

Byte(s)	Description	Length
1	Duration tag	1
2	Length = '02'	1
3	Time unit	1
4	Time interval	1

Time unit:

- Contents: time unit used; minutes, seconds or tenths of seconds;
- Coding:
 - '00' minutes;
 - '01' seconds;
 - '02' tenths of seconds;
 - All other values are reserved.

Time interval:

- Contents: the length of time required, expressed in units;
- Coding.

The time interval is coded in integer multiples of the time unit used. The range is from 1 unit to 255 units. The encoding is:

- '00': reserved;
- '01': 1 unit;
- '02': 2 units;
- ::
- 'FF': 255 units.

8.9 Item

Byte(s)	Description	Length
1	Item tag	1
2 to (Y-1)+2	Length (X)	Y
(Y-1)+3	Identifier of item	1
(Y-1)+4 to (Y-1)+X+2	Text string of item	X - 1

The identifier is a single byte between '01' and 'FF'. Each item shall have a unique identifier within an Item list.

The text string is coded in the same way as the alpha identifier for EF_{ADN}. Any unused bytes at the end of the value part shall be coded 'FF'.

8.10 Item identifier

Byte(s)	Description	Length
1	Item identifier tag	1
2	Length = '01'	1
3	Identifier of item chosen	1

The identifier is a single byte between '01' and 'FF', exactly the same as for the Item data object. A null item identifier is coded '00'.

8.11 Response length

Byte(s)	Description	Length
1	Response length tag	1
2	Length = '02'	1
3	Minimum length of response	1
4	Maximum length of response	1

The range of length is between '00' and 'FF'. A minimum length coding of '00' indicates that there is no minimum length requirement; a maximum length coding of 'FF' indicates that there is no maximum length requirement. If a fixed length is required the minimum and maximum values are identical.

8.12 Result

Byte(s)	Description	Length
1	Result tag	1
2 to (Y-1)+2	Length (X)	Y
(Y-1)+3	General result	1
(Y-1)+4 to (Y-1)+X+2	Additional information on result	X-1

General result:

- Contents: General result specifies the result and indicates appropriate UICC action;
- Coding:
 - '00' = Command performed successfully;
 - '01' = Command performed with partial comprehension;
 - '02' = Command performed, with missing information;
 - '03' = REFRESH performed with additional EFs read;
 - '04' = Command performed successfully, but requested icon could not be displayed;
 - '05' = Command performed, but modified by call control by NAA;
 - '06' = Command performed successfully, limited service;
 - '07' = Command performed with modification;
 - '08' = REFRESH performed but indicated NAA was not active;
 - '10' = Proactive UICC session terminated by the user;
 - '11' = Backward move in the proactive UICC session requested by the user;
 - '12' = No response from user;
 - '13' = Help information required by the user;
 - '14' = reserved for GSM/3G.
 - Results '0X' and '1X' indicate that the command has been performed:
 - '20' = terminal currently unable to process command;
 - '21' = Network currently unable to process command;
 - '22' = User did not accept the proactive command;
 - '23' = User cleared down call before connection or network release;
 - '24' = Action in contradiction with the current timer state;
 - '25' = Interaction with call control by NAA, temporary problem;
 - '26' = Launch browser generic error code.
 - Results '2X' indicate to the UICC that it may be worth re-trying the command at a later opportunity:
 - '30' = Command beyond terminal's capabilities;
 - '31' = Command type not understood by terminal;
 - '32' = Command data not understood by terminal;

- '33' = Command number not known by terminal;
- '34' = reserved for GSM/3G;
- '35' = reserved for GSM/3G;
- '36' = Error, required values are missing;
- '37' = reserved for GSM/3G;
- '38' = MultipleCard commands error;
- '39' = Interaction with call control by NAA, permanent problem;
- '3A' = Bearer Independent Protocol error;
- '3B' = Access Technology unable to process command.
- Results '3X' indicate that it is not worth the UICC re-trying with an identical command, as it will only get the same response. However, the decision to retry lies with the application.

The application should avoid a rapid sequence of repeated retried commands as this may be detrimental to terminal performance.

All other values are reserved.

Additional information.

- Contents:
 - For the general result "Command performed successfully", some proactive commands require additional information in the command result. This is defined in the clauses below. For the general results '20', '21', '26', '38', '39' and '3A', it is mandatory for the terminal to provide a specific cause value as additional information, as defined in the clauses below. For the other general results, the terminal may optionally supply additional information. If additional information is not supplied, then the length of the value part of the data object need only contain the general result.

8.12.1 Void

8.12.2 Additional information for terminal problem

For the general result "terminal currently unable to process command", it is mandatory for the terminal to provide additional information, the first byte of which to be as defined below:

- '00' = No specific cause can be given;
- '01' = Screen is busy;
- '02' = terminal currently busy on call;
- '03' = reserved for GSM/3G;
- '04' = No service;
- '05' = Access control class bar;
- '06' = Radio resource not granted;
- '07' = Not in speech call;
- '08' = reserved for GSM/3G;
- '09' = ME currently busy on SEND DTMF command;
- '0A' = No NAA active.

All other values shall be interpreted by the UICC as '00'. The coding '00' shall only be used by the terminal if no others apply.

8.12.3 Additional information for network problem

For the general result "network currently unable to process command", it is mandatory for the terminal to provide additional information.

The information provided and its coding is specific to the NAA. Bit 8 shall be set to '1'. One further value is defined:

- '00' = No specific cause can be given.

All other values shall be interpreted by the UICC as '00'. The coding '00' shall only be used by the terminal if no others apply.

8.12.4 Void

8.12.5 Void

8.12.6 Void

8.12.7 Void

8.12.8 Additional information for interaction with call control

For the general result "interaction with call control by NAA by NAA, permanent problem", it is mandatory for the terminal to provide additional information, the first byte of which to be as defined below:

- '00' = No specific cause can be given;
- '01' = Action not allowed;
- '02' = The type of request has changed.

All other values shall be interpreted by the UICC as '00'. The coding '00' shall only be used by the terminal if no others apply.

8.12.9 Additional information for MultipleCard commands

This clause applies if class "a" is supported.

For the general result "MultipleCard commands error", it is mandatory for the terminal to provide additional information, the first byte of which is defined below:

- '00' = No specific cause can be given;
- '01' = Card reader removed or not present;
- '02' = Card removed or not present;
- '03' = Card reader busy;
- '04' = Card powered off;
- '05' = C-APDU format error;
- '06' = Mute card;
- '07' = Transmission error;

- '08' = Protocol not supported;
- '09' = Specified reader not valid.

All other values shall be interpreted by the UICC as '00'. The coding '00' shall only be used by the terminal if no others apply.

8.12.10 Additional information for launch browser problem

For the general result "launch browser generic error code", it is mandatory for the terminal to provide additional information, the first byte of which to be as defined below:

- '00' = No specific cause can be given;
- '01' = Bearer unavailable;
- '02' = Browser unavailable;
- '03' = terminal unable to read the provisioning data.

All other values shall be interpreted by the UICC as '00'. The coding '00' shall only be used by the terminal if no others apply.

8.12.11 Additional information for Bearer Independent Protocol

This clause applies if class "e" or "f" is supported.

For the general result "Bearer Independent Protocol error", it is mandatory for the terminal to provide additional information, the first byte of which is defined below:

- '00' = No specific cause can be given;
- '01' = No channel available;
- '02' = Channel closed;
- '03' = Channel identifier not valid;
- '04' = Requested buffer size not available;
- '05' = Security error (unsuccessful authentication);
- '06' = Requested UICC/terminal interface transport level not available;
- '07' = remote device is not reachable (not present, not physically connected, switched off, etc.);
- '08' = Service error (service not available on remote device);
- '09' = Service identifier unknown.

All other values shall be interpreted by the UICC as '00'. The coding '00' shall only be used by the terminal if no others apply.

8.13 3GPP- SMS TPDU

Contents and coding: see TS 131.111 [26].

8.14 Void

8.15 Text string

Byte(s)	Description	Length
1	Text string tag	1
2 to (Y-1)+2	Length (X)	Y
(Y-1)+3	Data coding scheme	1
(Y-1)+4 to (Y-1)+X+2	Text string	X-1

A null text string shall be coded with Length = '00', and no Value part.

Data coding scheme is coded as for SMS Data coding scheme defined in TS 123 038 [3].

The following Data coding scheme values are recommended:

- '00': GSM default alphabet 7 bits packed;
- '04': GSM default alphabet 8 bits;
- '08': UCS2.

8.15.1 Coding of text in unpacked format

This is indicated by the data coding scheme having a value of '04' GSM default alphabet 8 bits data.

This string use the SMS default 7-bit coded alphabet as defined in TS 123 038 [3] with bit 8 set to 0. It may or may not include formatting characters, but all such formatting characters shall be taken from the set given in the SMS alphabet.

NOTE: This is exactly the same format as is used for EF_{ADN} alpha-identifiers. It is also the same as SMS messages that have been "unpacked".

8.15.2 Coding of text in packed format

This is indicated by the data coding scheme having a value of '00' SMS default alphabet 7 bits packed.

This string shall use the SMS default 7-bit coded alphabet, packed into 8-bit octets, as defined in TS 123 038 [3]. It may or may not include formatting characters, but all such formatting characters shall be taken from the set given in the SMS alphabet.

If the total number of characters in the text string equals $(8n-1)$ where $n = 1, 2, 3, \text{etc.}$ then there are 7 spare bits at the end of the message. To avoid the situation where the receiving entity confuses 7 binary zero pad bits as the @ character, the carriage return (i.e. <CR>) character shall be used for padding in this situation, as defined in TS 123 038 [3].

NOTE: This is the same format as is used in SMS messages to and from the network.

8.15.3 Coding of text in 16 bits UCS2 alphabet format

This is indicated by the data coding scheme having a value of '08' 16 bit UCS2 alphabet.

This string shall use the UCS2 alphabet if the UCS2 is supported, as defined in TS 123 038 [3]. It may or may not include formatting characters, but all such formatting characters shall be taken from the set given in the UCS2 alphabet.

NOTE: This is the same format as is used in SMS messages to and from the network.

8.16 Tone

Byte(s)	Description	Length
1	Tone tag	1
2	Length = '01'	1
3	Tone	1

- Tone:
- Contents:
 - Tones can be either the standard supervisory tone, as defined in the appropriate technology specific standards, or proprietary tones defined by the terminal manufacturer. The code values for proprietary tones shall be supported by the terminal. If proprietary tones are not supported the terminal shall map these codings to tones that it can generate. The tones to be used are left as an implementation decision by the manufacturer;
- Coding:
 - Standard supervisory tones:
 - '01' Dial tone;
 - '02' Called subscriber busy;
 - '03' Congestion;
 - '04' Radio path acknowledge;
 - '05' Radio path not available/Call dropped;
 - '06' Error/Special information;
 - '07' Call waiting tone;
 - '08' Ringing tone.
 - Terminal proprietary tones:
 - '10' General beep;
 - '11' Positive acknowledgement tone;
 - '12' Negative acknowledgement or error tone;
 - '13' Ringing tone as selected by the user for incoming speech call;
 - '14' Alert tone as selected by the user for incoming SMS.
 - All other values are reserved.

8.17 Void

8.18 File list

Byte(s)	Description	Length
1	File List tag	1
2 to (Y-1)+2	Length (X) of bytes following	Y
(Y-1)+3	Number of files (n)	1
(Y-1)+4 to (Y-1)+X+2	Files	X-1

Number of files:

- Contents: this is the number of files that will be described in the following list.

Files:

- full paths are given to files. Each of these shall be at least 4 octets in length (e.g. '3F002FE2' or '3F007F106F3A'). Each entry in the file description is composed of two bytes, where the first byte identifies the type of file (see TS 102 221 [1] or TS 151 011 [8]);
- the path '3F007FFF' indicates the relevant NAA Application dedicated file;
- an entry in the file description shall therefore always begin with '3FXX'. There can be any number of Dedicated File entries between the Master File and Elementary File. There shall be no delimiters between files, as this is implied by the fact that the full path to any EF starts with '3FXX' and ends with an Elementary type file.

8.19 Location information

Byte(s)	Description	Length
1	Location Information tag	1
2	Length = X	1
3 - 2+X	Access technology specific Location Information	X

Location information coding is defined by the different access technologies.

8.20 IMEI

Byte(s)	Description	Length
1	IMEI tag	1
2	Length = '08'	1
3 - 10	IMEI of the terminal	8

The IMEI is coded as in TS 124 008 [20].

8.21 Help request

Byte(s)	Description	Length
1	Help Request tag	1
2	Length = '00'	1

8.22 Network measurement results

Byte(s)	Description	Length
1	Network Measurement Results tag	1
2	Length = '10'	1
3 - 18	Network Measurement Results	16

- Coding: defined by the different access technologies.

8.23 Default text

The coding of this data object is the same as for the Text String data object (see clause 8.15) with the exception that the Default Text tag has a specific value (see clause 9.3).

8.24 Items next action indicator

Byte(s)	Description	Length
1	Items Next Action Indicator tag	1
2	Length (X)	1
3 to 3+X-1	Items Next Action Indicator list	X

- Contents:
 - Each item of a list of items has a next action indicator coded on one byte. The length of the Items Next Action Indicator list shall be the number of items of the list of items (X shall be the number of items in the list). The order of each item next action indicator, shall reflect the order of the items in the list of items.
 - The Item Next action indicator gives the possible actions that will be initiated by the UICC in case of selection by the user.
- Coding:
 - If the value is equal to '00' or if the value is reserved (that is, value not listed), the terminal shall ignore the next action indicator type.

See clause 9.4 for further information.

EXAMPLE: For the following list of items:

- item #1;
- item #2;
- item #3;
-;
- item #n.

The Items Next Action Indicator (NAI) shall be as follows:

Tag	Length	NAI#1	NAI#2	NAI#3	...	NAI#n
-----	--------	-------	-------	-------	-----	-------

8.25 Event list

Byte(s)	Description	Length
1	Event list tag	1
2 to Y+1	Length (X) of bytes following	Y
Y+2 to X+Y+1	Event list	X

Event list:

- Contents:
 - A list of events, of variable length. Each byte in the list defines an event. Each event type shall not appear more than once within the list;
- Coding:
 - Each byte in the event list shall be coded with one of the values below:
 - '00' = MT call;
 - '01' = Call connected;
 - '02' = Call disconnected;
 - '03' = Location status;

- '04' = User activity;
- '05' = Idle screen available;
- '06' = Card reader status;
- '07' = Language selection;
- '08' = Browser termination;
- '09' = Data available;
- '0A' = Channel status;
- '0B' = Access Technology Change;
- '0C' = Display parameters changed;
- '0D' = Local connection.

8.26 Cause

Byte(s)	Description	Length
1	Cause tag	1
2	Length (X) of bytes following. $X=0$, or $2 \leq X \leq 30$	1
3 to X+2	Cause	X

The cause value is defined in the appropriate access technology specification. Radio Link Timeout is indicated by the Cause data object having a value part of zero length (only the Tag and Length components are sent).

8.27 Location status

Byte(s)	Description	Length
1	Location status tag	1
2	Length (X) of bytes following	1
3	Location status	1

Location status:

- Contents:
 - This data object indicates the current service state of the terminal:
 - "normal service" shall indicate that the terminal is in a state where all requests for services are treated normally;
 - "limited service" shall indicate that the terminal is in a state where only emergency call services are offered;
 - "no service" shall indicate that the terminal is in a state where no services are offered.
- Coding:
 - Each byte in the event list shall be coded with one of the values below:
 - '00' = Normal service;
 - '01' = Limited service;
 - '02' = No service.

8.28 Transaction identifier

Coding according to specific technology.

8.29 Void

8.30 Call control requested action

Byte(s)	Description	Length
1	Call control requested action tag	1
2 to (Y-1)+2	Length (X)	Y
(Y-1)+3 to (Y-1)+X+2	Call control requested action	X

- Contents:
 - The action given in response to the ENVELOPE (CALL CONTROL).
- Coding:
 - As described in clause 7.3.1.6, starting with the first optional element given in the response data to the ENVELOPE (CALL CONTROL). The TLV elements shall be in the same order as given by the UICC.

8.31 Icon identifier

Byte(s)	Description	Length
1	Icon identifier tag	1
2	Length = '02'	1
3	Icon qualifier	1
4	Icon identifier	1

Icon qualifier:

- Contents:
 - The icon qualifier indicates to the terminal how the icon is to be used.
- Coding:
 - bit 1: 0 = icon is self-explanatory, i.e. if displayed, it replaces the alpha identifier or text string;
 - 1 = icon is not self-explanatory, i.e. if displayed, it shall be displayed together with the alpha identifier or text string.
 - bits 2-8 = 0 RFU.

Icon identifier:

- Contents: The icon identifier addresses a record in EF_{IMG} as defined in TS 131 102 [6].
- Coding: Binary.

8.32 Item icon identifier list

Byte(s)	Description	Length
1	Items Icon identifier tag	1
2	Length (X) of bytes following	1
3	Icon list qualifier	1
4 to 4+X-2	Icon identifier list	X-1

Icon list qualifier:

- Contents:
 - The icon list qualifier indicates to the terminal how the icons are to be used.
- Coding:
 - bit 1: 0 = icon is self-explanatory, i.e. if displayed, it replaces the item text;
 - 1 = icon is not self-explanatory, i.e. if displayed, it shall be displayed together with the item text.
 - bits 2-8 = 0 RFU.

All icons in the list shall be treated in the same manner by the terminal, i.e. either none of the icons in this list are displayed, or for each item its related icon is displayed.

Icon identifier list:

- Contents:
 - Each item of a list of items has an icon identifier coded on one byte. The length of the Items icon identifier list shall be the number of items of the list of items (X-1 shall be the number of items in the list). The order of each item icon identifier, shall reflect the order of the items in the list of items.
 - Each icon identifier addresses a record in EF_{IMG} as defined in TS 131 102 [6].
- Coding: Binary.

EXAMPLE: For the following list of items:

- item #1;
- item #2;
- item #3;
-;
- item #n.

The Items icon identifier list shall be as follows:

Tag	Length	Icon list qualifier	icon identifier#1	icon identifier#2	icon identifier#3	...	icon identifier #n

8.33 Card reader status

Byte(s)	Description	Length
1	Card reader status tag	1
2	Length	1
3	Card reader status	1

- Contents:
 - This contains the identity of the card reader, and flags to indicate the status of the reader with respect to:
 - whether the card reader is removable or permanently connected;
 - whether the card reader is present (this can only be false if the card reader is removable);
 - whether the card reader present accepts ID-1 size cards (this can only be true if the card reader is present);
 - whether there is a card present in the card reader (this can only be true if the card reader is present);
 - whether power is being applied to the card (this can only be true if a card is present).
- Coding:
 - The value of this byte indicates the identity and status of a card reader:
 - bits 1-3 = Identity of card reader x.
 - bit 4 0 = Card reader is not removable;
 1 = Card reader is removable.
 - bit 5 0 = Card reader is not present;
 1 = Card reader is present.
 - bit 6 0 = Card reader present is not ID-1 size;
 1 = Card reader present is ID-1 size.
 - bit 7 0 = No card present;
 1 = Card is present in reader.
 - bit 8 0 = No card powered;
 1 = Card in reader is powered.

8.34 Card ATR

Byte(s)	Description	Length
1	Card ATR tag	1
2	Length (X) of bytes following	1
3 to (X+2)	ATR	X

ATR:

- Contents:
 - This is the Answer To Reset returned by the card.
- Coding:
 - The coding of the Answer To Reset is defined in ISO/IEC 7816-3 [13].

8.35 C-APDU

Byte(s)	Description	Length
1	C-APDU tag	1
2 to (Y+1)	Length (X) of bytes following (Y = 1 or 2)	Y
Y+2	Command class CLA	1
Y+3	Command instruction code INS	1
Y+4	P1 parameter	1
Y+5	P2 parameter	1
Y+6	Lc (optional)	0 or 1
(Y+7) to (Y+X)	Data (optional)	Lc
Y+X+1	Le (optional)	0 or 1

This object contains the command APDU for Card x in the format defined in ISO/IEC 7816-4 [14]. Command class CLA, instruction code INS, P1 and P2 parameters, Lc, Data and Le are coded as defined in ISO/IEC 7816-4 [14]. Extended lengths are not supported.

NOTE: The maximum size of the value part of this Simple TLV (value of X) is limited to 241 bytes, so the maximum length for the Data (value of Lc) in a Case 3 type of APDU is 236 bytes.

8.36 R-APDU

Byte(s)	Description	Length
1	R-APDU tag	1
2 to Y+1	Length (X) of bytes following (Y = 1 or 2)	Y
Y+2 to Y+X-1	R-APDU data (optional)	X-2
Y+X	Status word SW1	1
Y+X+1	Status word SW2	1

This object contains the response APDU from Card x in the format defined in ISO/IEC 7816-4 [14]. The R-APDU data and status words SW1 and SW2 are coded as defined in ISO/IEC 7816-4 [14]. It is possible for no R-APDU data to be present; this is indicated by the length of the data object.

NOTE: The maximum size of the value part of this Simple TLV (value of X) is limited to 239 bytes, so the maximum length of the R-APDU data is 237 bytes.

8.37 Timer identifier

Byte(s)	Description	Length
1	Timer identifier tag	1
2	Length='01'	1
3	Timer identifier	1

- Timer identifier:
 - Contents: identifier of a timer;
 - Coding:
 - '01' Timer 1;
 - '02' Timer 2;
 - '03' Timer 3;
 - '04' Timer 4;
 - '05' Timer 5;

- '06' Timer 6;
- '07' Timer 7;
- '08' Timer 8.

All other values are reserved.

8.38 Timer value

Byte(s)	Description	Length
1	Timer value tag	1
2	Length='03'	1
3 - 5	Timer value	3

- Timer value:
 - Contents: value of a timer, expressed using the format hour, minute, second;
 - Coding:
 - byte 3: hour; this byte is coded exactly in the same way as the hour field of the TP-Service-Centre-Time-Stamp in TS 123 040 [27];
 - byte 4: minute; this byte is coded exactly in the same way as the minute field of the TP-Service-Centre-Time-Stamp in TS 123 040 [27];
 - byte 5: second; this byte is coded exactly in the same way as the second field of the TP-Service-Centre-Time-Stamp in TS 123 040 [27].

8.39 Date-time and time zone

Byte(s)	Description	Length
1	Date-Time and Time zone tag	1
2	Length = '07'	1
3 to 9	Date-Time and Time zone	7

Date-Time and Time Zone:

- Contents:
 - Date, Time and Time Zone
- Coding:
 - byte 3: Year; this byte is coded exactly in the same way as the Year field of the TP-Service-Centre-Time-Stamp in TS 123 040 [27];
 - byte 4: Month; this byte is coded exactly in the same way as the Month field of the TP-Service-Centre-Time-Stamp in TS 123 040 [27];
 - byte 5: Day; this byte is coded exactly in the same way as the Day field of the TP-Service-Centre-Time-Stamp in TS 123 040 [27];
 - byte 6: Hour; this byte is coded exactly in the same way as the Hour field of the TP-Service-Centre-Time-Stamp in TS 123 040 [27];
 - byte 7: Minute; this byte is coded exactly in the same way as the Minute field of the TP-Service-Centre-Time-Stamp in TS 123 040 [27];
 - byte 8: Second; this byte is coded exactly in the same way as the Second field of the TP-Service-Centre-Time-Stamp in TS 123 040 [27];

- byte 9: Time Zone; this byte is coded exactly in the same way as the Time Zone field of the TP-Service-Centre-Time-Stamp in TS 123 040 [27]. 'FF' indicates an unknown value.

8.40 AT command

Byte(s)	Description	Length
1	AT Command tag	1
2 to (Y-1)+2	Length (X)	Y
(Y-1)+3 to (Y-1)+3+X-1	AT Command string	X

- Contents:
 - The AT Command string is structured exactly as the AT Command line as defined in TS 127 007 [5], which may contain single or concatenated AT commands. Each NAA may have its specific AT command specification.

8.41 AT response

Byte(s)	Description	Length
1	AT Response tag	1
2 to (Y-1)+2	Length (X)	Y
(Y-1)+3 to (Y-1)+3+X-1	AT Response string	X

- Contents:
 - The AT Response string is structured exactly as the response to a command line as defined in TS 127 007 [5], which may contain single or concatenated responses appropriate to the issued AT command. Each NAA may have its specific AT command specification.
 - If the AT Response string is longer than the maximum length capable of being transmitted to the UICC then the AT Response string shall be truncated to this length by the terminal.

8.42 BC repeat indicator

Byte(s)	Description	Length
1	BC repeat indicator tag	1
2	Length	1
3	BC repeat indicator values	1

BC repeat indicator coding is defined by the different access technologies.

8.43 Immediate response

This TLV object is used in the sustained DISPLAY TEXT command.

Byte(s)	Description	Length
1	Immediate response tag	1
2	Length='00'	1

8.44 DTMF string

Byte(s)	Description	Length
1	DTMF String tag	1
2 to (Y-1)+2	Length (X)	Y
(Y-1)+3 to (Y-1)+3+X-1	DTMF string	X

- Contents:
 - The DTMF string which can be single or multiple characters is coded in BCD, in the same way as the Dialling number string defined for EF_{ADN} in TS 131 102 [6]. It may include extended BCD coding. There is no need for a DTMF control digit separator at the beginning of the string, but if present it shall be interpreted as PAUSE.

8.45 Language

Byte(s)	Description	Length
1	Language tag	1
2	Length = '02'	1
3-4	Language	2

- Coding:
 - Each language code is a pair of alpha-numeric characters, defined in ISO 639 [12]. Each alpha-numeric character shall be coded on one byte using the SMS default 7-bit coded alphabet as defined in TS 123 038 [3] with bit 8 set to 0.

8.46 Void

8.47 Browser identity

Byte(s)	Description	Length
1	Browser identity tag	1
2	Length	1
3	Browser Identity	1

- Coding:
 - 00 = Default Browser shall be used;
 - Other values are RFU.

8.48 URL

Byte(s)	Description	Length
1	URL tag	1
2 to (Y+1)	Length (X)	Y
(Y+2) to (Y+1+X)	URL	X

A null URL shall be coded with Length = '00', and no Value part. In that case, the terminal shall use the default URL.

- Coding:
 - The data used for the URL shall be coded as defined in RFC 1738 [11] on using the "SMS 7bit default alphabet" with bit 8 set to 0.

8.49 Bearer

Byte(s)	Description	Length
1	Bearer tag	1
2 to (Y+1)	Length (X)	Y
(Y+2) to (Y+X+1)	List of bearers in order of priority requested	X

The terminal shall use this list to choose which bearers are allowed in order of priority.

- Coding:
 - '00' = short message;
 - '01' = circuit switched data;
 - '02' = reserved for GSM/3G;
 - '03' = packet switched;
 - '04' to 'FF' = RFU.

8.50 Provisioning file reference

Byte(s)	Description	Length
1	Provisioning file reference tag	1
2 to (Y+1)	Length (X)	Y
(Y+2) to (Y+X+1)	Path to the provisioning file	X

NOTE: The path is the concatenation of file identifiers starting from the Master File, e.g. 3F007F106FX Y, etc.

The file shall contain a single unambiguous set of parameters required to make the connection. The content of the file shall be consistent with the format defined for provisioning information for the requested type of browser.

8.51 Browser termination cause

Byte(s)	Description	Length
1	Browser Termination Cause tag	1
2	Length (1)	1
3	Browser Termination Cause	1

- Coding:
 - 00 = User Termination;
 - 01 = Error Termination.

8.52 Bearer description

Byte(s)	Description	Length
1	Bearer description tag	1
2	Length (X+1)	1
3	Bearer type	1
4 to (3+X)	Bearer parameters	X

- Coding of the Bearer Type:
 - '01' = reserved for GSM/3GPP CSD;
 - '02' = reserved for GSM/3GPP packet data service;
 - '03' = default bearer for requested transport layer.
 - '04' = local link technology independent;
 - '05' = Bluetooth;
 - '06' = IrDA;
 - '07' = RS232;
 - '08' = TIA/EIA/IS-820 packet data service [17];
 - '10' = USB.

All other values are reserved.

- Coding of the Bearer Parameters:
 - default bearer;
 - parameters specific to the bearer;
 - when the default bearer is present, the terminal shall provide its default available bearer parameter configuration. X (length of parameters) = 0;
 - local links (Bluetooth, IrDA, RS232, USB);
 - in this case, X = variable. Contains "Service Identifier" and "Service Record" fields as defined in clause 8.63 and according to the Bearer Type coding;
 - other bearers.

The coding is defined in the appropriate access technology specific specification.

8.53 Channel data

Byte(s)	Description	Length
1	Channel data tag	1
2 to Y+1	Length (X)	Y
(Y+2) to (Y+X+1)	Channel data string	X

- Contents:
 - the Channel data object contains application data read from or written to a specific channel buffer in the terminal.

- Coding:
 - the Channel data string shall be considered by the terminal as binary coded on 8 bits.

8.54 Channel data length

Byte(s)	Description	Length
1	Channel data length tag	1
2	Length (1)	1
3	Channel data length	1

- Contents:
 - either the number of bytes that are available in a channel buffer (Tx or Rx buffers negotiated during OPEN CHANNEL) using TERMINAL RESPONSE. Since the Tx or Rx buffer size can be larger than 255 bytes, 'FF' means "more than 255 bytes are available"; or
 - the number of bytes that are requested in a RECEIVE DATA command.

8.55 Buffer size

Byte(s)	Description	Length
1	Buffer size tag	1
2	Length (2)	1
3 to 4	Buffer size	2

- Contents:
 - the Buffer size codes the number of bytes requested by the UICC in an OPEN CHANNEL command or what the terminal can offer the UICC (placed in TERMINAL RESPONSE).

8.56 Channel status

Byte(s)	Description	Length
1	Channel status tag	1
2	Length (2)	1
3 to 4	Channel status	2

- Contents:
 - the Channel status is a string of binary coded characters.
- Coding:
 - byte 3:
 - bit 1 to 3: Channel identifier: 1..7;
 - Channel identifier 0 means "No channel available".
 - bit 4 to 7: RFU;
 - bit 8: 0 = Link not established or Packet data service not activated;
1 = Link established or Packet data service activated.

- byte 4:
 - '00' = No further info can be given;
 - '01' = Not used;
 - '02' = Not used;
 - '03' = Not used;
 - '04' = Not used;
 - '05' = Link dropped;
 - all other values are reserved.

8.57 Card reader identifier

Byte(s)	Description	Length
1	Card reader identifier tag	1
2	Length (X)	1
3 to (X+2)	Identifier of card reader	X

Identifier of card reader:

- Contents:
 - this contains manufacturer-specific information to identify the type of card reader being used.
- Coding:
 - the identifier of card reader is coded in hexadecimal.

8.58 Other address

Byte(s)	Description	Length
1	Other address tag	1
2	Length (X)	1
3	Type of address	1
4 to (X+2)	Address	X-1

A null Local address shall be coded with Length = '00', and no Value part. In that case, the terminal shall request a dynamic address.

- Coding of Type of address:
 - '21' = IPv4 address;
 - '57' = IPv6 address;
 - 'others' = reserved.
- Coding of address:
 - If type of address indicates IPv4, the Address information in octet 4 to octet 7 contains the IPv4 address. Bit 8 of octet 4 represents the most significant bit of the IP address and bit 1 of octet 7 the least significant bit.
 - If type of address indicates IPv6, the Address information in octet 4 to octet 19 contains the IPv6 address. Bit 8 of octet 4 represents the most significant bit of the IP address and bit 1 of octet 19 the least significant bit.

8.59 UICC/terminal interface transport level

This clause applies if class "e" is supported.

Byte(s)	Description	Length
1	UICC/terminal interface transport level tag	1
2	Length (X+1)	1
3	Transport protocol type	1
4 to 5	Port number	2

- Coding of the Transport protocol type:
 - '01': UDP (as defined in RFC 768 [9]);
 - '02': TCP (as defined in RFC 793 [10]);
 - all other values are reserved.
- Coding of the Port number:
 - integer.

8.60 AID

Byte(s)	Description	Length
1	AID tag	1
2	Length (X)	1
3 to (X+2)	AID	X

- Contents:
 - Application identifier as defined in TS 101 220 [31].

8.61 Access technology

Byte(s)	Description	Length
1	Access Technology tag	1
2	Length = '01'	1
3	Technology	1

- Contents:
 - the terminal shall use this information as a mechanism to indicate to the UICC the current access technology that it is using.
- Coding:
 - '00' = GSM;
 - '01' = EIA/TIA-553;
 - '02' = TIA/EIA-136;
 - '03' = UTRAN;
 - '04' = TETRA;
 - '05' = TIA/EIA-95;
 - '06' = TIA/EIA/IS-2000.

All other values are reserved for future use.

8.62 Display parameters

Byte(s)	Description	Length
1	Display parameters tag	1
2	Length = '03'	1
3 to 5	Parameters list	3

- Contents:
 - A list of different information regarding the terminal's screen.
- Coding:
 - One bit is used to code parameters supported or not:
 - bit = 1: parameters supported by terminal;
 - bit = 0: parameters not supported by terminal.

First byte: (Screen height)

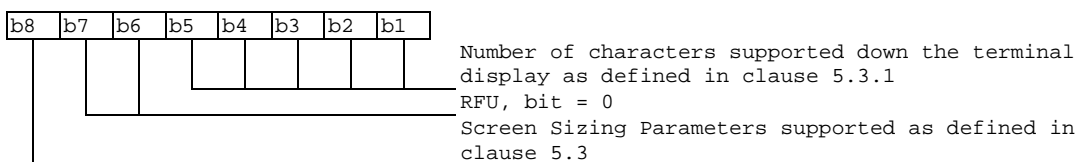

Second byte: (Screen width)

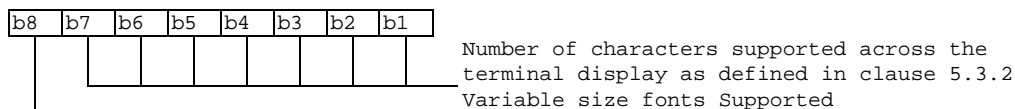

Third byte: (Screen effects)

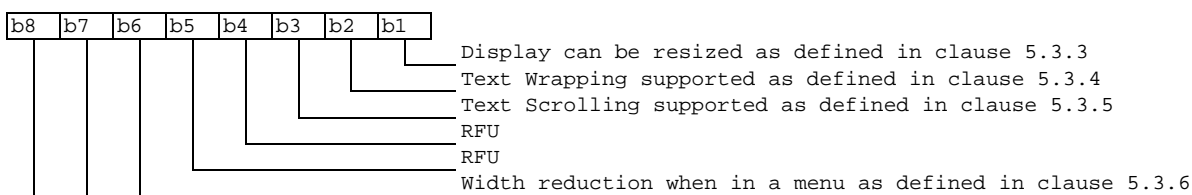

8.63 Service record

This service record can have different formats that are dependent on the technology they are associated with.

This object can be used in both directions (ME to UICC or UICC to ME), when a CAT application needs to declare a service that it supports (DECLARE SERVICE command) and when CAT application searches for a service (GET SERVICE INFORMATION).

Byte(s)	Description	Length
1	Service Record tag	1
2 to Y+1	Length (X+2)	Y
Y+2	Local Bearer technology identifier	1
Y+3	Service Identifier	1
Y+4 to Y+X+3	Service Record	X

Local Bearer Technology identifier:

- Coding:
 - '00' = Technology independent: '00';
 - '01' = Bluetooth;
 - '02' = IrDA;
 - '03' = RS232;
 - '04' = USB;
 - '05' to 'FF' = RFU.

Service identifier

- Coding:
 - When declaring a service, the UICC associates a Service Identifier to the Service Record. When the Service Record TLV is returned in response to GET SERVICE INFORMATION, Service Identifier shall be set to 'FF'.
 - '00' to '07' Service x (0 to 7). Value assigned by UICC;
 - 'FF' = Service Record related to the service provided by a remote device.

Other value reserved for future use.

Service Record:

When the Service Record field is not meaningful, it shall be assigned the value = '00'.

- Technology Independent:
 - RFU.
- Bluetooth:
 - In Bluetooth, a Service record gives all needed information that must be used by a device to connect and use this service. The full description of the coding of these records is given in the Bluetooth Specification in the SDP section [16]. When Service Record is returned in response to GET SERVICE INFORMATION, it corresponds to the AttributeList parameter contained in the SDP_ServiceAttributeResponse PDU [16].
 - Strings should be limited to 20 bytes because of the T=0 protocol limitation (255 bytes) and because the service record may include several text strings with length possibly higher than 255 bytes.
- IrDA:
 - RFU.
- RS232:
 - RFU.

- USB:
 - RFU.

Depending on the proactive command, the parameters of this TLV could be either meaningful or optional. The following table indicates in which case the parameters are required.

Proactive command	Service Identifier required	Service Record field required
DECLARE SERVICE (add)	Yes	Yes
DECLARE SERVICE (delete)	Yes	No (value '00' assigned)
terminal response of a GET SERVICE INFORMATION	No (value 'FF' assigned)	Yes
OPEN CHANNEL (client)	No (value 'FF' assigned)	Yes
OPEN CHANNEL (server)	Yes	No (value '00' assigned)
Local Connection event	Yes	No (value '00' assigned)

8.64 Device filter

Byte(s)	Description	Length
1	Device Filter tag	1
2 to Y+1	Length (1+X1+X2+...+Xn)	Y
Y+2	Local Bearer technology identifier	1
Y+3 to Y+2+X	Device Filter	X

Local Bearer Technology identifier: see clause 8.63.

Device filter.

If the Local Bearer Technology Identifier is different from '00', the device filter coding is technology dependent.

- Technology Independent: RFU;
- Bluetooth:
 - The Device Filter parameter is used to filter the responses to a service search. For Bluetooth, it is a list of Class_Of_Device and Class_Of_Device_Mask.
 - Device Filter =
 - Class_Of_Device_1 [3 bytes], Class_Of_Device_Mask_1 [3 bytes];
 - Class_Of_Device_2 [3 bytes], Class_Of_Device_Mask_2 [3 bytes];
 - ...;
 - Class_Of_Device_n [3 bytes], Class_Of_Device_Mask_n [3 bytes].
- IrDA: RFU;
- RS232: RFU;
- USB: RFU.

8.65 Service search

Byte(s)	Description	Length
1	Service Search tag	1
2 to Y+1	Length (X+1)	Y
Y+2	Local Bearer technology identifier	1
Y+3 to Y+X+1	Service Search	X

Local Bearer Technology identifier: see clause 8.63.

Service search:

If the Local Bearer Technology Identifier is different from '00', the Service search coding is technology dependent.

- Technology Independent:
 - RFU.
- Bluetooth:
 - The Service Search field is the *ServiceSearchPattern* parameter of the *SDP_ServiceSearchRequest* command as defined in the Bluetooth specification [16].
- IrDA:
 - RFU.
- RS232:
 - RFU.
- USB:
 - RFU.

8.66 Attribute information

Byte(s)	Description	Length
1	Item tag	1
2 to Y+1	Length (X+1)	Y
Y+2	Local Bearer technology identifier	1
Y+3 to Y+X+2	Attribute Information	X

Local Bearer Technology identifier: see clause 8.63.

Attribute Information:

If the Local Bearer Technology Identifier is different from '00', the Attribute Information coding is technology dependent.

- Technology Independent:
 - RFU.
- Bluetooth:
 - The Attribute Information field consists of a *BD_ADDR*, followed by the *ServiceRecordHandle* and the *AttributeIDList* parameters of the *SDP_ServiceAttributeRequest* command as defined in the Bluetooth specification [16].
 - The *BD_ADDR* is the Bluetooth device address of the device the terminal shall connect to. The terminal shall use the *ServiceRecordHandle* and the *AttributeIDList* parameters to perform the *SDP_ServiceAttributeRequest*. The *ServiceRecordHandle* has been previously retrieved with the *SERVICE SEARCH* command.
- IrDA:
 - RFU.
- RS232:
 - RFU.

- USB:
 - RFU.

8.67 Service availability

The Service Availability parameter contains a list of available services that the SERVICE SEARCH command returns. This object is formatted according to the local bearer technology identifier byte set in the SERVICE SEARCH command arguments.

Byte(s)	Description	Length
1	Service Availability tag	1
2 to Y+1	Length='X1'+ 'X2'+ 'X3'+... 'Xn' (n maxi = 7)	Y
Y+2 to Y+X1+1	Service_1	X1
Y+X1+2 to Y+X1+X2+1	Service_2	X2
...
Y+X1+...+X(n-1)+2 to Y+X1+...+Xn+1	Service_n	Xn

- Technology Independent:
 - RFU.
- Bluetooth:
 - For Bluetooth, Service_i = BD_ADDR_i[6 bytes] + ServiceRecordHandle_i[4 bytes] + CoD_i[3 bytes] + Device_Name_i[20 bytes], those parameters being defined in the Bluetooth specification [16]. Device Name parameter should be truncated to 20 bytes because of the T=0 protocol limitation (255 bytes) and because device name parameter length can be higher than 255 bytes.

Byte(s)	Description	Length
1	Service Availability tag	1
2 to Y+1	Length='X1'+ 'X2'+ 'X3'+... 'Xn' (n maxi = 7)	Y
Y+2 to Y+X1+1	BD_ADDR + ServiceRecordHandle + CoD + Device_Name	X1
Y+X1+2 to Y+X1+X2+1	BD_ADDR + ServiceRecordHandle + CoD + Device_Name	X2
...
Y+X1+...+X(n-1)+2 to Y+X1+...+Xn+1	BD_ADDR + ServiceRecordHandle + CoD + Device_Name	Xn

- IrDA:
 - RFU.
- RS232:
 - RFU.
- USB:
 - RFU.

8.68 Remote entity address

Byte(s)	Description	Length
1	Remote Entity Address tag	1
2 to Y+1	Length (X+1)	Y
Y+2	Coding Type	1
Y+3 to Y+X+2	Remote Entity address	X

- Coding Type:
 - '00': IEEE-802 48-bit address;
 - '01': to 'FF' are reserved values.
- Remote Entity Address: according to Coding Type.

8.69 ESN

Byte(s)	Description	Length
1	ESN tag	1
2	Length = '04'	1
3 - 6	ESN of the terminal	4

The ESN is coded as in TIA/EIA-41-D [18].

8.70 Network access name

Byte(s)	Description	Length
1	Network Access Name tag	1
2	Length (X)	1
3 to 3+X-1	Network Access Name	X

- Content:
 - The Network Access Name is used to identify the Gateway entity, which provides interworking with an external packet data network.
- Coding:
 - Defined by the different access technologies.

8.71 CDMA-SMS TPDU

- Contents and coding:
 - 3GPP2 C.S0015 [29].

9 Tag values

This clause specifies the tag values used to identify the BER-TLV and SIMPLE-TLV data objects used in the present document, and reserve the technology specific Tags.

9.1 BER-TLV tags in terminal to UICC direction

Description	Length of tag	Value
Reserved for GSM/3G/3GPP2 (SMS-PP download tag)	1	'D1'
Reserved for GSM/3G/3GPP2 (Cell Broadcast download tag)	1	'D2'
Menu Selection tag	1	'D3'
Call control tag	1	'D4'
Reserved for GSM/3G (MO Short message control tag)	1	'D5'
Event download tag	1	'D6'
Timer expiration	1	'D7'

9.2 BER-TLV tags in UICC TO terminal direction

Description	Length of tag	Value
Proactive UICC command tag	1	'D0'

9.3 SIMPLE-TLV tags in both directions

Description	Length of tag	Tag value, bits 1-7 (Range: '01' - '7E')	Tag (CR and Tag value)
Command details tag	1	'01'	'01' or '81'
Device identity tag	1	'02'	'02' or '82'
Result tag	1	'03'	'03' or '83'
Duration tag	1	'04'	'04' or '84'
Alpha identifier tag	1	'05'	'05' or '85'
Address tag	1	'06'	'06' or '86'
Capability configuration parameters tag	1	'07'	'07' or '87'
Subaddress tag	1	'08'	'08' or '88'
Reserved for GSM/3G (SS string tag)	1	'09'	'09' or '89'
Reserved for GSM/3G (USSD string tag)	1	'0A'	'0A' or '8A'
Reserved for GSM/3G (SMS TPDU tag)	1	'0B'	'0B' or '8B'
Reserved for GSM/3G (Cell Broadcast page tag)	1	'0C'	'0C' or '8C'
Text string tag	1	'0D'	'0D' or '8D'
Tone tag	1	'0E'	'0E' or '8E'
Item tag	1	'0F'	'0F' or '8F'
Item identifier tag	1	'10'	'10' or '90'
Response length tag	1	'11'	'11' or '91'
File List tag	1	'12'	'12' or '92'
Location Information tag	1	'13'	'13' or '93'
IMEI tag	1	'14'	'14' or '94'
Help request tag	1	'15'	'15' or '95'
Network Measurement Results tag	1	'16'	'16' or '96'
Default Text tag	1	'17'	'17' or '97'
Items Next Action Indicator tag	1	'18'	'18' only
Event list tag	1	'19'	'19' or '99'
Reserved for GSM/3G (Cause tag)	1	'1A'	'1A' or '9A'
Location status tag	1	'1B'	'1B' or '9B'
Reserved for GSM/3G (Transaction identifier tag)	1	'1C'	'1C' or '9C'
Reserved for GSM/3G (BCCH channel list tag)	1	'1D'	'1D' or '9D'
Icon identifier tag	1	'1E'	'1E' or '9E'
Item Icon identifier list tag	1	'1F'	'1F' or '9F'
Card reader status tag	1	'20'	'20' or 'A0'
Card ATR tag	1	'21'	'21' or 'A1'
C-APDU tag	1	'22'	'22' or 'A2'
R-APDU tag	1	'23'	'23' or 'A3'
Timer identifier tag	1	'24'	'24' or 'A4'
Timer value tag	1	'25'	'25' or 'A5'
Date-Time and Time zone tag	1	'26'	'26' or 'A6'
Call control requested action tag	1	'27'	'27' or 'A7'
AT Command tag	1	'28'	'28' or 'A8'
AT Response tag	1	'29'	'29' or 'A9'
Reserved for GSM/3G (BC Repeat Indicator tag)	1	'2A'	'2A' or 'AA'
Immediate response tag	1	'2B'	'2B' or 'AB'
DTMF string tag	1	'2C'	'2C' or 'AC'
Language tag	1	'2D'	'2D' or 'AD'
Reserved for GSM/3G (Timing Advance tag)	1	'2E'	'2E' or 'AE'
AID tag	1	'2F'	'2F' or 'AF'
Browser Identity tag	1	'30'	'30' or 'B0'
URL tag	1	'31'	'31' or 'B1'
Bearer tag	1	'32'	'32' or 'B2'
Provisioning Reference File tag	1	'33'	'33' or 'B3'
Browser Termination Cause tag	1	'34'	'34' or 'B4'

Description	Length of tag	Tag value, bits 1-7 (Range: '01' - '7E')	Tag (CR and Tag value)
Bearer description tag	1	'35'	'35' or 'B5'
Channel data tag	1	'36'	'36' or 'B6'
Channel data length tag	1	'37'	'37' or 'B7'
Channel status tag	1	'38'	'38' or 'B8'
Buffer size tag	1	'39'	'39' or 'B9'
Card reader identifier tag	1	'3A'	'3A' or 'BA'
Not used	1	'3B'	'3B' or 'BB'
UICC/terminal interface transport level tag	1	'3C'	'3C' or 'BC'
Not used	1	'3D'	'3D' or 'BD'
Other address (data destination address) tag	1	'3E'	'3E' or 'BE'
Access Technology tag	1	'3F'	'3F' or 'BF'
Display parameters tag	1	'40'	'40' or 'C0'
Service Record tag	1	'41'	'41' or 'C1'
Device Filter tag	1	'42'	'42' or 'C2'
Service Search tag	1	'43'	'43' or 'C3'
Attribute information tag	1	'44'	'44' or 'C4'
Service Availability tag	1	'45'	'45' or 'C5'
ESN tag	1	'46'	'46' or 'C6'
Network Access Name tag	1	'47'	'47' or 'C7'
Reserved for 3GPP2 (CDMA-SMS-TPDU)	1	'48'	'48' or 'C8'
Remote Entity Address tag	1	'49'	'49' or 'C9'
Reserved for 3GPP (PDP context Activation par. Tag)	1	'52'	'52' or 'D2'
Reserved for TIA/EIA-136	1	'60'	'60' or 'E0'
Reserved for TIA/EIA-136	1	'61'	'61' or 'E1'

9.4 Type of command and next action indicator

The table below shows the values which shall be used for Type of Command coding (see clause 8.6) and Next Action Indicator coding (see clause 8.24).

Value	Name	Used for Type of Command coding	Used for Next Action Indicator coding
'00'		-	-
'01'	REFRESH	X	
'02'	MORE TIME	X	
'03'	POLL INTERVAL	X	
'04'	POLLING OFF	X	
'05'	SET UP EVENT LIST	X	
'10'	SET UP CALL	X	X
'11'	Reserved for GSM/3G (SEND SS)	X	X
'12'	Reserved for GSM/3G (SEND USSD)	X	X
'13'	SEND SHORT MESSAGE	X	X
'14'	SEND DTMF	X	
'15'	LAUNCH BROWSER	X	X
'20'	PLAY TONE	X	X
'21'	DISPLAY TEXT	X	X
'22'	GET INKEY	X	X
'23'	GET INPUT	X	X
'24'	SELECT ITEM	X	X
'25'	SET UP MENU	X	X
'26'	PROVIDE LOCAL INFORMATION	X	
'27'	TIMER MANAGEMENT	X	
'28'	SET UP IDLE MODE TEXT	X	X
'30'	PERFORM CARD APDU	X	X
'31'	POWER ON CARD	X	X
'32'	POWER OFF CARD	X	X
'33'	GET READER STATUS	X	X
'34'	RUN AT COMMAND	X	
'35'	LANGUAGE NOTIFICATION	X	
'40'	OPEN CHANNEL	X	X

Value	Name	Used for Type of Command coding	Used for Next Action Indicator coding
'41'	CLOSE CHANNEL	X	X
'42'	RECEIVE DATA	X	X
'43'	SEND DATA	X	X
'44'	GET CHANNEL STATUS	X	X
'45'	SERVICE SEARCH	X	X
'46'	GET SERVICE INFORMATION	X	X
'47'	DECLARE SERVICE	X	
'81'	End of the proactive session	not applicable	X

10 Allowed type of command and device identity combinations

Only certain types of commands can be issued with certain device identities. These are defined below.

Command description	Source	Destination
CALL CONTROL	Terminal	UICC
COMMAND RESULT	Terminal	UICC
DISPLAY TEXT	UICC	Display
EVENT DOWNLOAD		
- MT call	Network	UICC
- Call connected at near end (MT call)	Terminal	UICC
- Call connected at far end (MO call)	Network	UICC
- Call disconnected at near end	Terminal	UICC
- Call disconnected at far end	Network	UICC
- Location status	Terminal	UICC
- User activity	Terminal	UICC
- Idle screen available	Display	UICC
- Card reader status	Terminal	UICC
- Language selection	Terminal	UICC
- Browser termination	Terminal	UICC
- Data available	Terminal	UICC
- Channel status	Terminal	UICC
- Access Technology Change	Terminal	UICC
- Display parameters changed	Terminal	UICC
- Local connection	Network	UICC
GET INKEY	UICC	Terminal
GET INPUT	UICC	Terminal
GET READER STATUS		
- If card reader status requested	UICC	Terminal
- If card reader identifier requested	UICC	Card reader x
LANGUAGE NOTIFICATION	UICC	Terminal
LAUNCH BROWSER	UICC	Terminal
MENU SELECTION	Keypad	UICC
MORE TIME	UICC	Terminal
PERFORM CARD APDU	UICC	Card reader x
PLAY TONE	UICC	Earpiece (see note)
POLLING OFF	UICC	Terminal
POLL INTERVAL	UICC	Terminal
POWER ON CARD	UICC	Card reader x
POWER OFF CARD	UICC	Card reader x
PROFILE DOWNLOAD	Terminal	UICC
PROVIDE LOCAL INFORMATION	UICC	Terminal
REFRESH	UICC	Terminal
RUN AT COMMAND	UICC	Terminal
SELECT ITEM	UICC	Terminal
SEND DTMF	UICC	Network
SEND SHORT MESSAGE	UICC	Network

Command description	Source	Destination
SET UP CALL	UICC	Network
SET UP EVENT LIST	UICC	Terminal
SET UP IDLE MODE TEXT	UICC	Terminal
SET UP MENU	UICC	Terminal
TIMER MANAGEMENT	UICC	Terminal
TIMER EXPIRATION	Terminal	UICC
OPEN CHANNEL	UICC	Terminal
CLOSE CHANNEL	UICC	Channel x
RECEIVE DATA	UICC	Channel x
SEND DATA	UICC	Channel x
GET CHANNEL STATUS	UICC	Terminal
SERVICE SEARCH	UICC	Terminal
GET SERVICE INFORMATION	UICC	Terminal
DECLARE SERVICE	UICC	Terminal
NOTE: The terminal may route the tone to other loudspeakers (external ringer, car kit) if more appropriate.		

11 Security requirements

The generic parts of TS 123 048 [4] are in the process of being published as an EP SCP specification. When complete, the new specification will be referred to.

TS 123 048 [4] specifies standardized methods of securing the content of application messages. If it is necessary to secure application messaging to Toolkit applications, then TS 123 048 [4] may be used.

Annex A (normative): Support of CAT by terminal equipment

Support of CAT is optional for terminal Equipment. However, if a terminal states conformance with a specific CAT release, it is mandatory for the terminal to support all functions of that release.

The support of letter classes, which specify mainly terminal hardware dependent features, is optional for the terminal and may supplement the CAT functionality described in the present document. If a terminal states conformance to a letter class, it is mandatory to support all functions within the respective letter class.

Table A.1 indicates the commands and functions of the optional letter classes.

Table A.1: Description of letter classes

Letter classes	Command/function description
a	Proactive command: GET READER STATUS Proactive command: PERFORM CARD APDU Proactive command: POWER ON CARD Proactive command: POWER OFF CARD Event download: Card reader status
b	Proactive command: RUN AT COMMAND
c	Proactive command: LAUNCH BROWSER Event download: Browser termination event
d	Soft key support
e	Proactive command: OPEN CHANNEL Proactive command: CLOSE CHANNEL Proactive command: RECEIVE DATA Proactive command: SEND DATA Proactive command: GET CHANNEL STATUS Event download: Data available Event download: Channel status
f	Proactive command: SERVICE SEARCH Proactive command: GET SERVICE INFORMATION Proactive command: DECLARE SERVICE Event download: Local connection event

Annex B (informative): Example of DISPLAY TEXT proactive UICC command

Example of DISPLAY TEXT Proactive UICC Command (BER-TLV Data Object).

Table B.1: Example of DISPLAY TEXT

Byte#	Value (Hex)	Description
1	D0	Proactive UICC command tag
2	0F	Length
3	81	Command details tag
4	03	Length
5	01	Command number
6 to 7	21 00	Display text (normal priority, clear message after a delay)
8	82	Device identities tag
9	02	Length
10	81	Source: UICC
11	02	Destination: Display
12	8D	Text string tag
13	04	Length
14	04	Data coding scheme ('04'=8-bit default SMS)
15 to 17	43, 41, 54	Text string ("CAT")

Annex C (normative): Structure of CAT communications

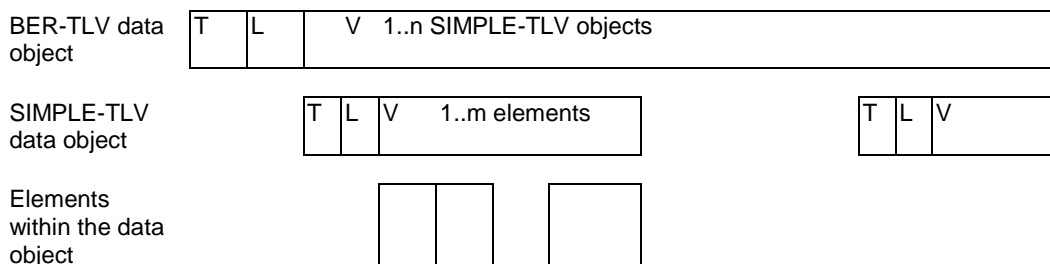

Figure C.1

CAT commands and responses are sent across the interface as BER-TLV data objects. Each APDU shall only contain one BER-TLV object. See ISO/IEC 7816-6 [15] for more information on data objects.

The tag of a BER-TLV is a constant value, length one byte, indicating it is a CAT command.

The length is coded onto 1, or 2 bytes according to ISO/IEC 7816-6 [15]. Table C.1 details this coding.

Table C.1

Length	Byte 1	Byte 2
0-127	length ('00' to '7F')	not present
128-255	'81'	length ('80' to 'FF')

Any length within the APDU limits (up to 255 bytes) can thus be encoded on two bytes. This coding is chosen to remain compatible with ISO/IEC 7816-6 [15].

Any values for byte 1 or byte 2 that are not shown above shall be treated as an error and the whole message shall be rejected.

The value part of the BER-TLV data object consists of SIMPLE-TLV data objects, as shown in the description of the SIMPLE-TLV data objects on individual commands. It is mandatory for SIMPLE-TLV data objects to be provided in the order given in the description of each command. New SIMPLE-TLV data objects can be added to the end of a command.

The structure of SIMPLE-TLV tags is defined in clause C.1.

The M/O/C columns specify whether it is mandatory, optional or conditional for the sender to send that particular SIMPLE-TLV data object for compliance with the current version of the present document. The Min (Minimum Set) column describes whether it is necessary for the receiver to have received that particular SIMPLE-TLV data object to be able to attempt at least the most basic form of this command. The procedure for dealing with incomplete messages is described in clause 6.10.

'00' and 'FF' are never used as tag values. This is in accordance with ISO/IEC 7816-6 [15]. Padding characters are not allowed.

C.1 SIMPLE-TLV tag format

SIMPLE-TLV tags can be in one of two formats: single byte and three-byte format.

The value of the first byte identifies the format used.

First byte value	Format
'00'	Not used, in accordance with ISO/IEC 7816-6 [15]
'01' - '7E'	Single byte
'7F'	Three-byte
'80'	Reserved for future use
'81' - 'FE'	Single byte
'FF'	Not used, in accordance with ISO/IEC 7816-6 [15]

The same value in the two formats represents the same data object.

C.1.1 Single byte format

The tag is coded over one byte.

8	7	6	5	4	3	2	1
CR		Tag value					

CR: Comprehension required for this object.

Unless otherwise stated, for SIMPLE-TLV data objects it is the responsibility of the UICC application and the terminal to decide the value of the CR flag for each data object in a given command.

Handling of the CR flag at the receiving entity is described in clause 6.10.

CR	Value
Comprehension required	1
Comprehension not required	0

C.1.2 Three-byte format

The tag is coded over three bytes.

Byte 1	Byte 2							Byte 3
	8	7	6	5	4	3	2	
Tag value format = '7F'	CR	Tag value						

Tag value format: Byte 1 equal to '7F' indicates that the tag is in the three-byte format.

CR: Comprehension required for this object. Use and coding is the same as in single byte format.

Tag value: Coded over 15 bits, with bit 7 of byte 2 as the most significant bit. Range is from '00 01' to '7F FF'.

Annex D (informative): Terminal display in proactive UICC session

Example of the terminal display whilst the terminal is in a proactive UICC session.

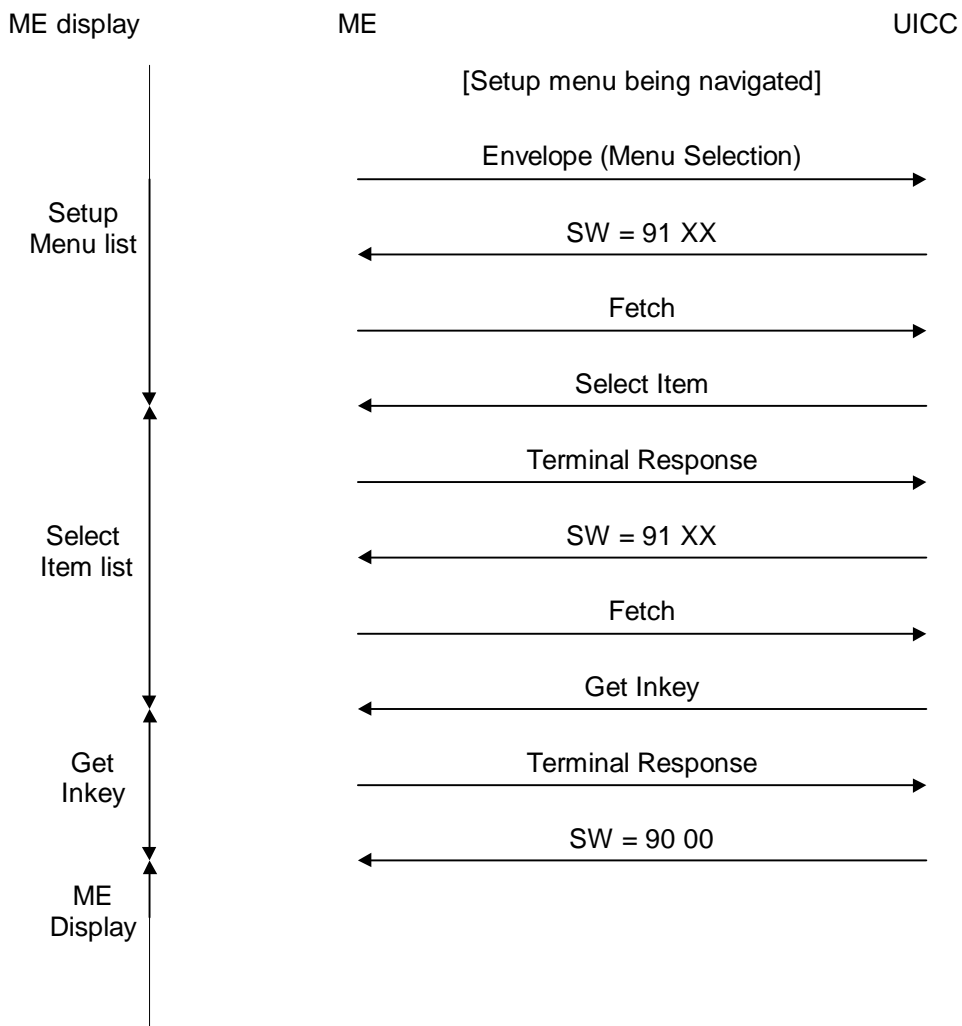

Figure D.1

Annex E (informative): Help information feature processing

The following example shows the use of the commands Menu Selection/Select Item and Get Input in conjunction with the help information feature.

Terminal	UICC
TERMINAL PROFILE	-----> <----- 91xx
FETCH	-----> <----- SET UP MENU (Help available)
TERMINAL RESPONSE (OK)	-----> <----- 90 00
...	
ENVELOPE (MENU SELECTION, help on menu item m)	-----> <----- 91 xx
FETCH	-----> <----- DISPLAY TEXT (Help info to item m)
TERMINAL RESPONSE (OK)	-----> <----- 90 00
(Terminal offers menu again and user selects item m)	
ENVELOPE (MENU SELECTION, select item m)	-----> <----- 91 xx
FETCH	-----> <----- SELECT ITEM (Item list under item m, help available)
TERMINAL RESPONSE (Help on item mn in item list under item m)	-----> <----- 91 xx
FETCH	-----> <----- DISPLAY TEXT (Help info to item mn)
TERMINAL RESPONSE (OK)	-----> <----- 91 xx
FETCH	-----> <----- Repetition of SELECT ITEM (Item list under item m, help available)
...	
FETCH	-----> <----- 91xx
FETCH	-----> <----- GET INPUT
TERMINAL RESPONSE (Help info required)	-----> <----- 91 xx
FETCH	-----> <----- DISPLAY TEXT (Help info)
TERMINAL RESPONSE (OK)	-----> <----- 91 xx
FETCH	-----> <----- Repetition of GET INPUT
TERMINAL RESPONSE (OK)	-----> ...
...	

Figure E.1

Annex F (informative): Monitoring of events

Some of the events monitored through the event download mechanism are reported by the terminal each time the event occurs, while other events are reported only once (the terminal removes the event type from the current event list once the event occurs). This is summarized in table F.1.

Table F.1

Event	Continuously reported	Reported once
MT call	X	
Call connected	X	
Call disconnected	X	
Location status	X	
User activity		X
Idle screen available		X
Card reader status	X	
Language selection	X	
Data available	X	
Channel status	X	
Browser termination	X	
Access Technology Change	X	
Display parameters changed	X	
Local connection	X	

Annex G (normative): Support of multiple card operation

This annex applies if class "a" is supported.

It is intended that Multiple Card commands are an optional extension to the basic CAT functionality in the present document.

The terminal is responsible for appropriate protocol management, as defined in ISO/IEC 7816-4 [14]. This includes APDU mapping and procedure byte handling.

If the terminal is already powered on and a UICC is active, then, when Card x is inserted, the terminal powers on Card x. The terminal shall identify if Card x contains the UICC application. If it does, TS 100 922 [19] applies. If it does not contain the UICC application, or it is not selected by the user for 3G operation, then the terminal powers off Card x. If applicable, the terminal shall send an event download (card reader status) message to the current UICC. When required, the CAT application of the current UICC card shall power on Card x and control communications, through the relevant proactive commands.

When the terminal is powered on, the terminal locates and selects the preferred UICC card defined in TS 100 922 [19]. If applicable, the terminal sends a terminal Profile command to the UICC. When required, the CAT application issues a Get Reader Status proactive command, which gets information on all readers and cards available to the CAT application. This procedure also applies if the terminal is already powered on with no UICC present, and a card is then inserted.

When the UICC issues a POWER ON CARD, and the terminal successfully receives an Answer To Reset from Card x, the terminal shall return a successful terminal Response containing the ATR, even if it does not understand the contents of the ATR, or support any of the protocols indicated.

The terminal shall ensure that Card x is deactivated according to ISO/IEC 7816-3 [13]. Where deactivation is not due to a POWER OFF CARD proactive command (e.g. card removed, card reader removed, or low battery), the event download (card reader status) procedure may also be applicable.

Annex H (informative): Multiple card proactive command examples

This annex applies if class "a" is supported.

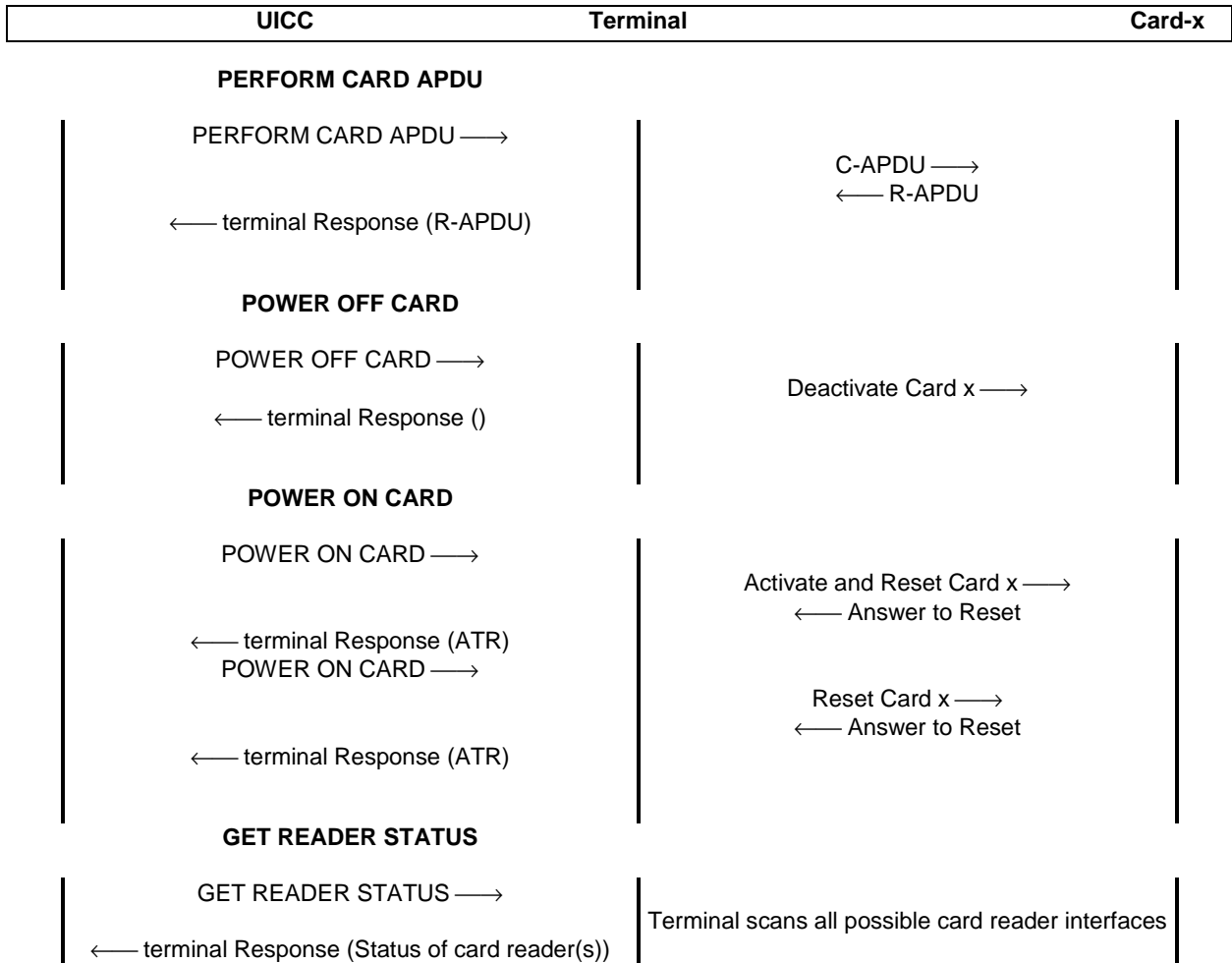
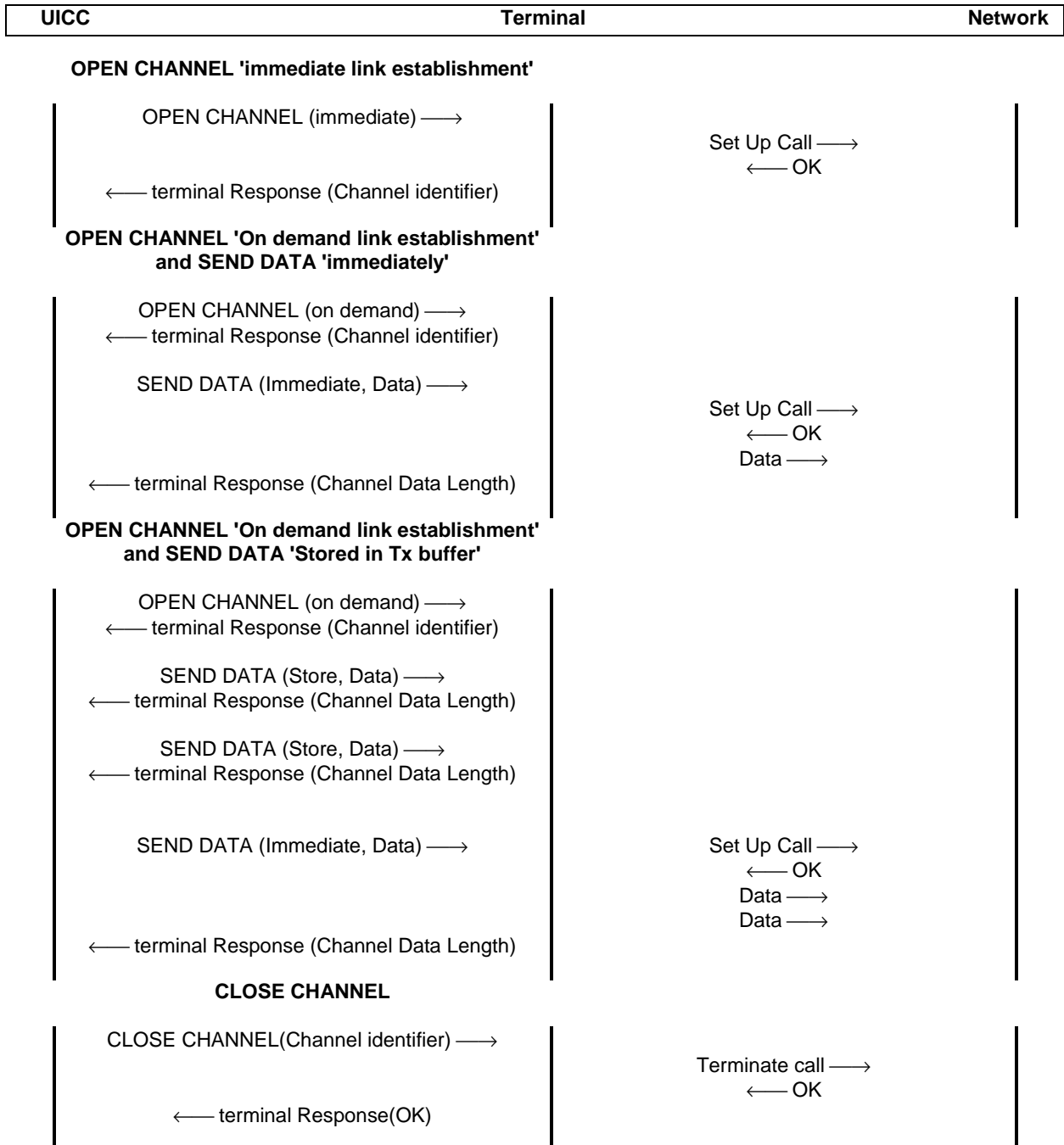

Figure H.1

Annex I (informative): Bearer independent protocol proactive command examples

This annex applies if class "e" is supported.



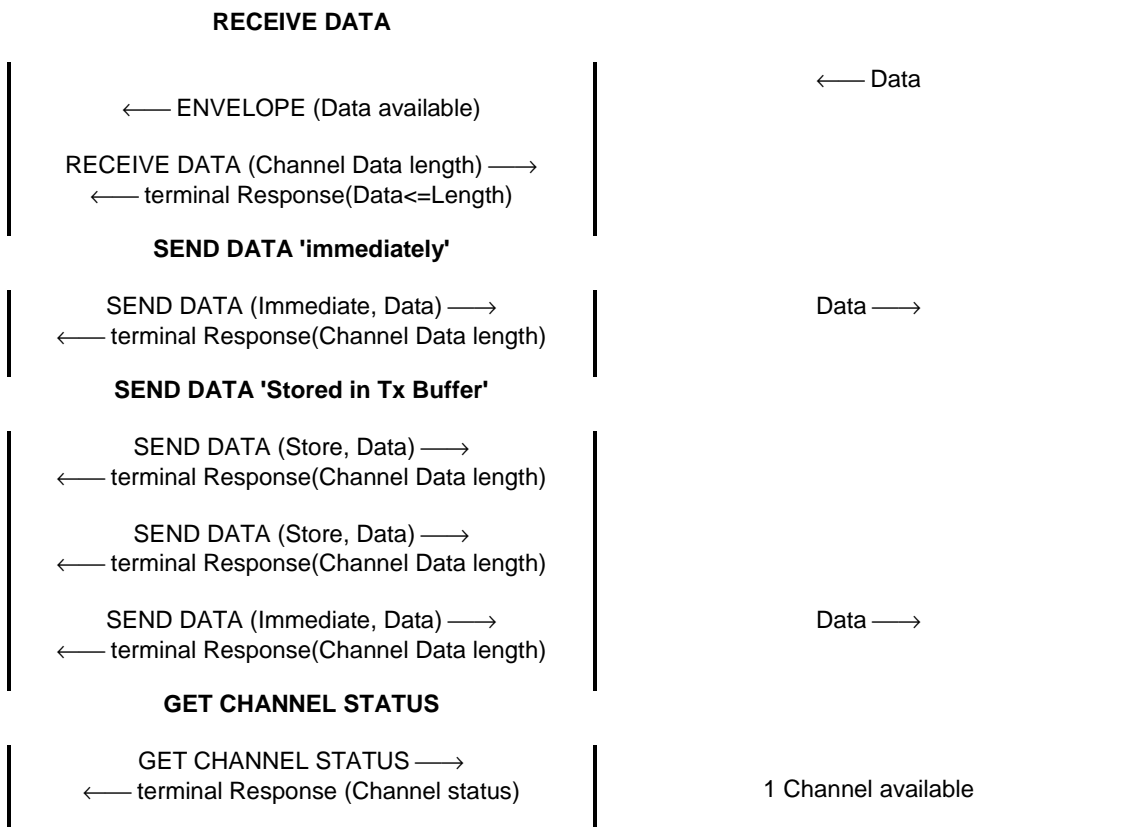
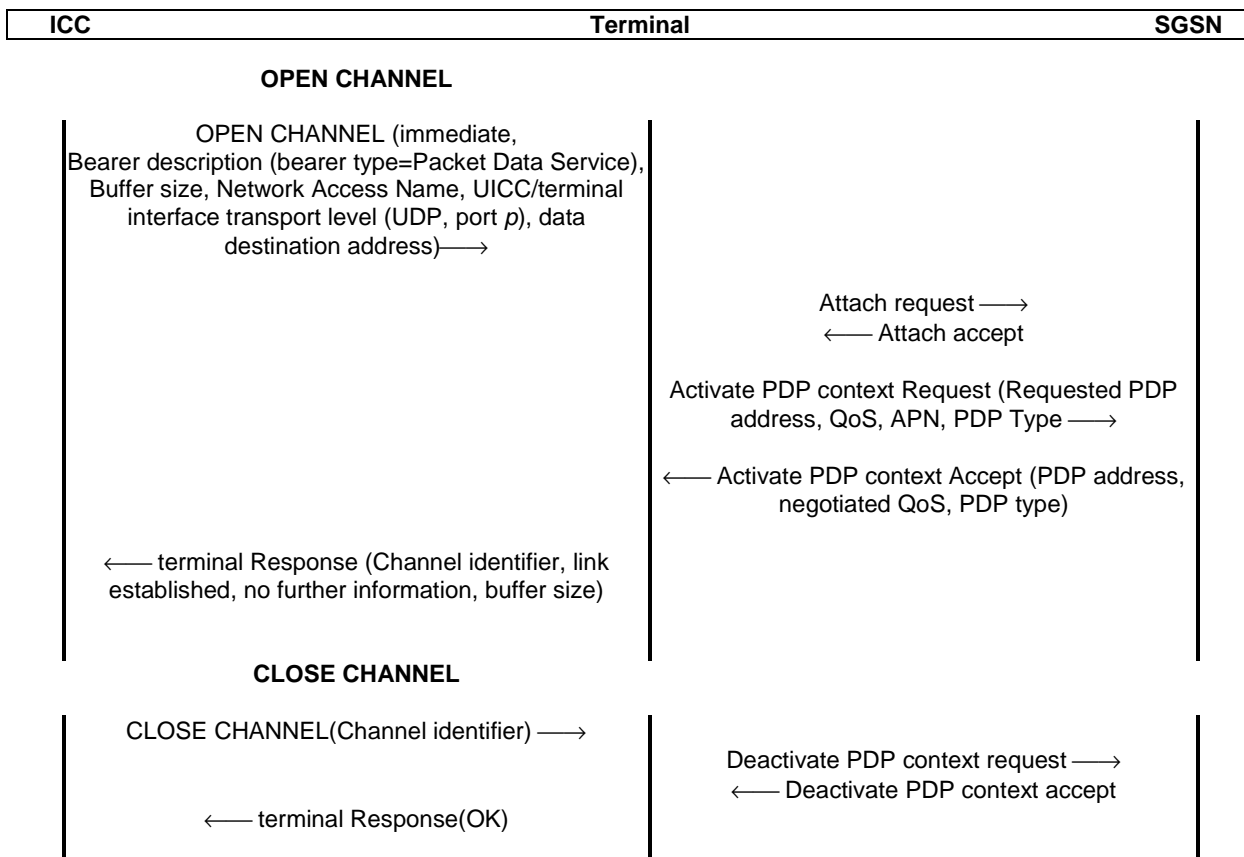

Figure I.1

EXAMPLE: Packet Data Service bearer applied to GPRS:



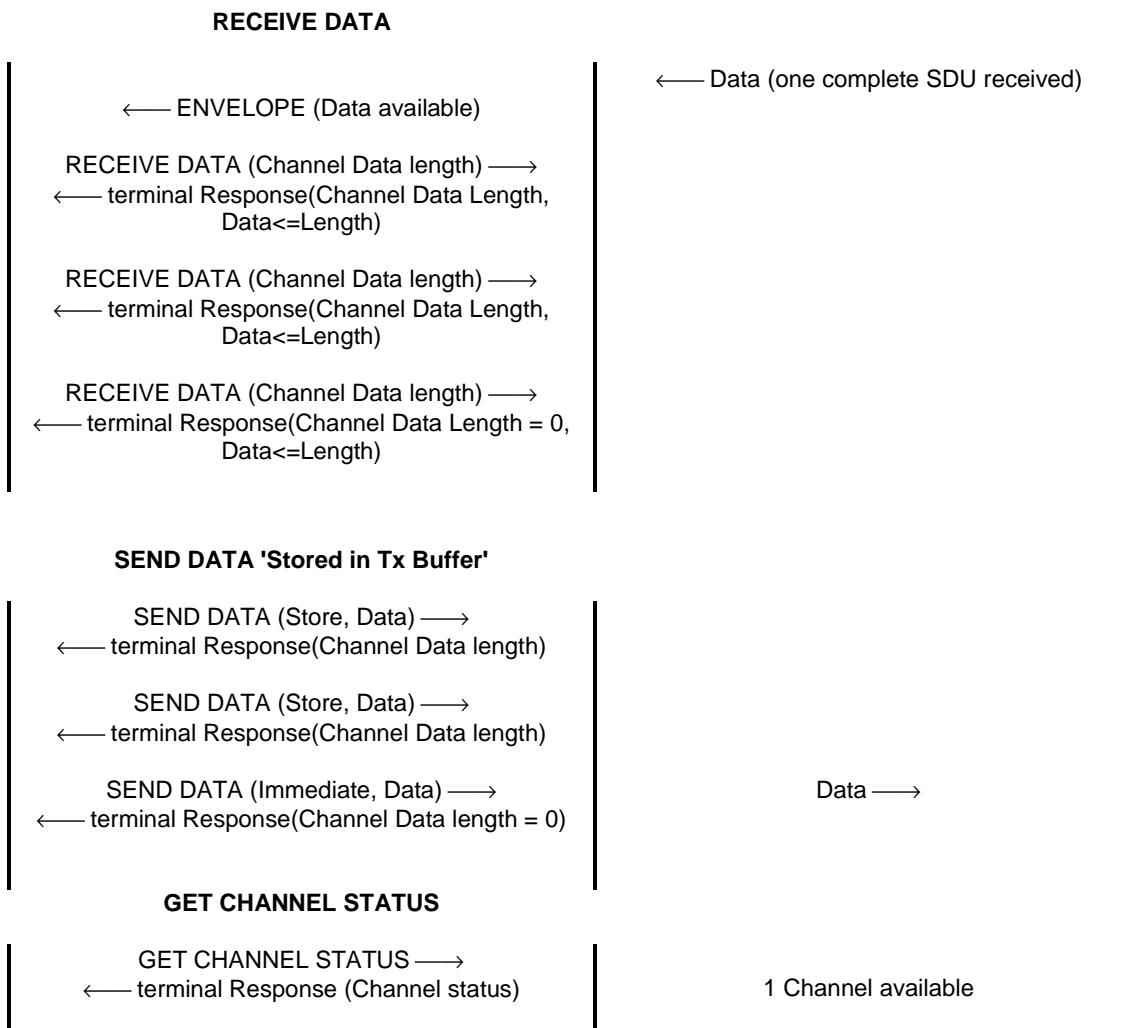

Figure I.2

Annex J (informative): WAP terminology

References:

- WAP specifications: <http://www.wapforum.org/>.
- WAP Smart card provisioning specification: <http://www.wapforum.org/>.

Definitions:

WAE User Agent: any software or device that interprets WML, WMLScript

WMLScript: scripting language used to run a program in the terminal device

Abbreviations:

WAE	Wireless Application Environment
WAP	Wireless Application Protocol
WML	Wireless Markup Language

Annex K (informative): Use of CAT bearer independent protocol for local links Bluetooth case

Bluetooth services to be run by the UICC should be developed so that the access to their service record is open and does not necessitate any security mechanism (no authentication or encryption).

K.1 Service search command

The Local Bearer Technology Identifier is Bluetooth. Service Search consists for the terminal in first performing a device discovery of the devices that conform to the Device Filter (inquiry responses are filtered according to the list of Class of Device given in the Device Filter); then performing an SDP_ServiceSearchRequest, as defined in the Bluetooth specification [16], on each device to check the support of the given service. The terminal shall then return the Service Availability data object which is a list of BD_ADDR, ServiceRecordHandle, CoD and Device Name.

Note for Handset Manufacturers:

- as the mobile is not always connected to other devices present in the remote environment (e.g. Bluetooth), when performing a service search, it is up to the terminal to set a procedure that allows:
 - a "scan" of the environment to discover new devices;
 - a connection to Service Discovery Servers of discovered devices;
 - a match with the requested service to set up the response to the CAT application.

K.2 Get service information command

The Local Bearer Technology Identifier is Bluetooth, GET SERVICE INFORMATION consists for the terminal in connecting to a specific device and performing an SDP_ServiceAttributeRequest PDU as defined in the Bluetooth specification [16]. The terminal shall then return the Service Record data object.

NOTE: When performing a GET SERVICE INFORMATION, it is up to the terminal to set up a connection with the requested device and perform the SDP exchange.

K.3 OPEN CHANNEL command

If the UICC/terminal interface parameter is not present, the UICC/terminal interface is the bearer level which is the RFCOMM level.

The Remote Entity Address shall be present and shall be the BD_ADDR of the remote device.

EXAMPLE: Interaction-CAT client case:

UICC	Terminal	Remote entity
------	----------	---------------

SERVICE RETRIEVAL

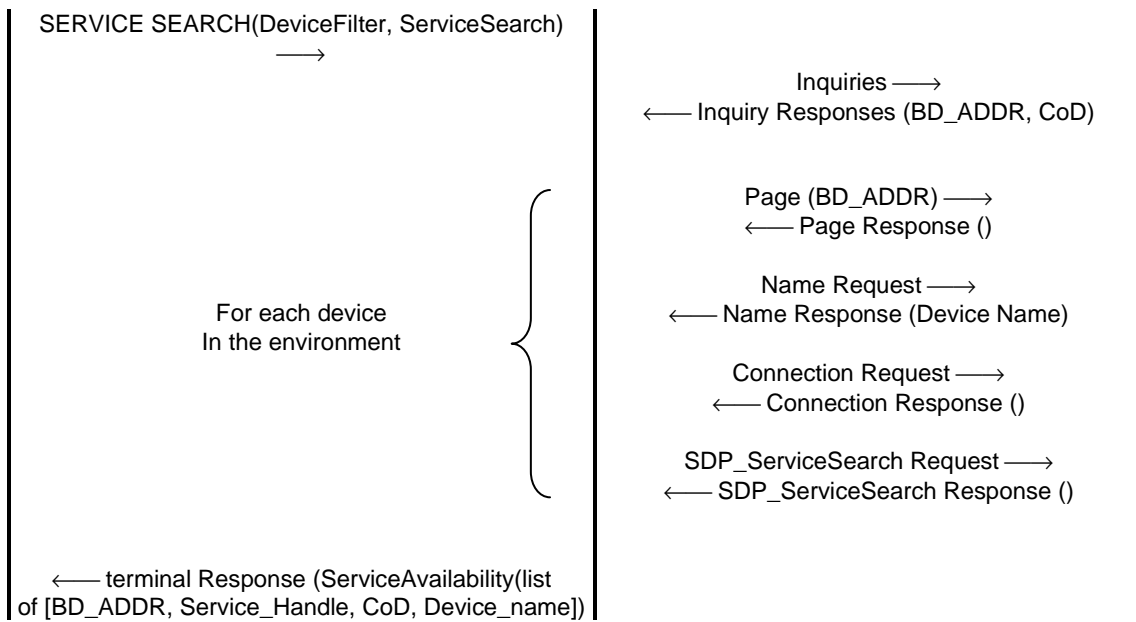

DETAILED INFORMATION ON SERVICE

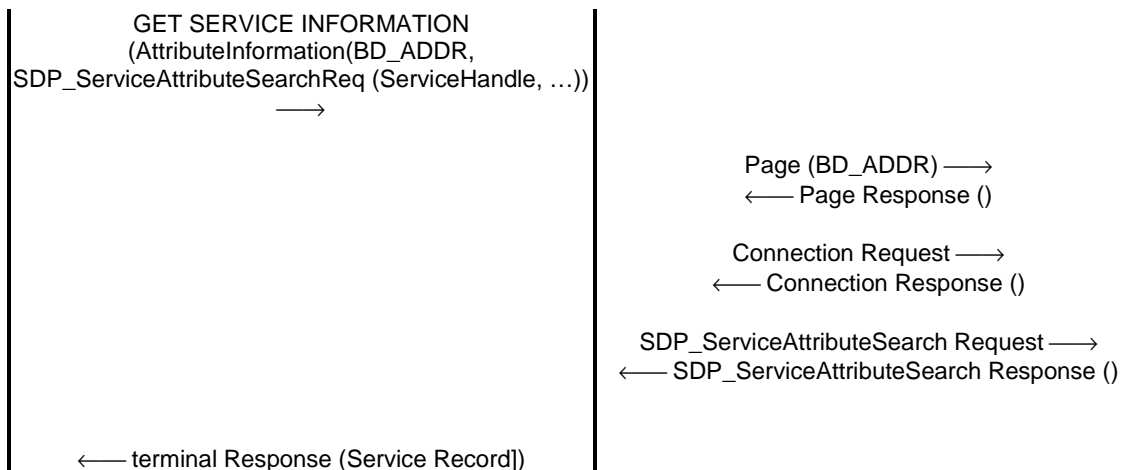

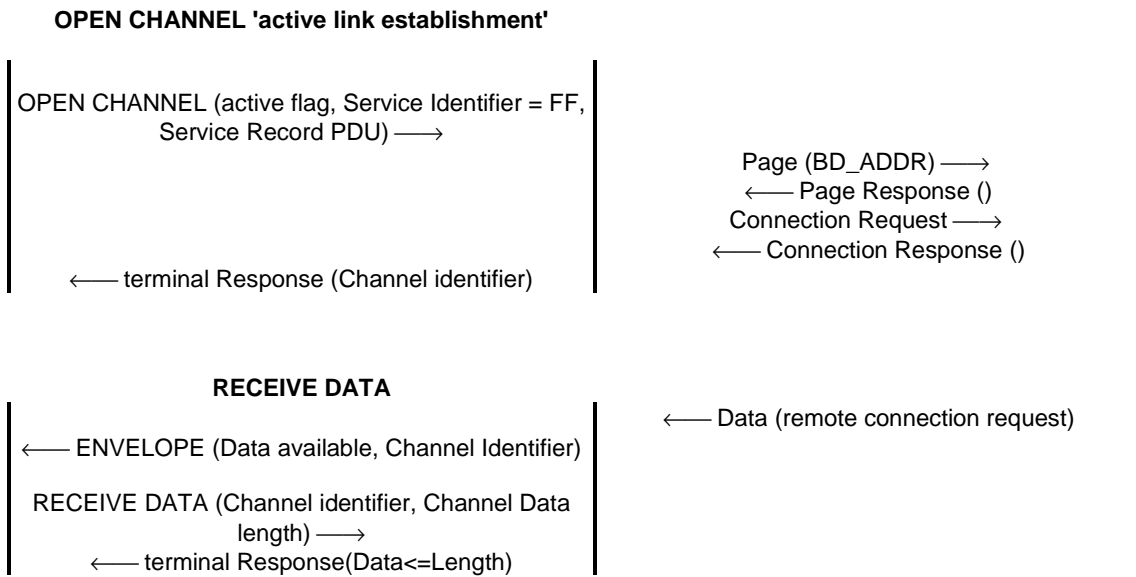

Figure K.1

Annex L (informative): Bluetooth service discovery protocol

The service Bluetooth protocol is used to provide a way to get information of services offered by device present in a same Bluetooth environment. Each device providing a service must have a SDP Server software that can be connected by any other device. This connection is set-up by a SDP Client software and is performed in a one to one process.

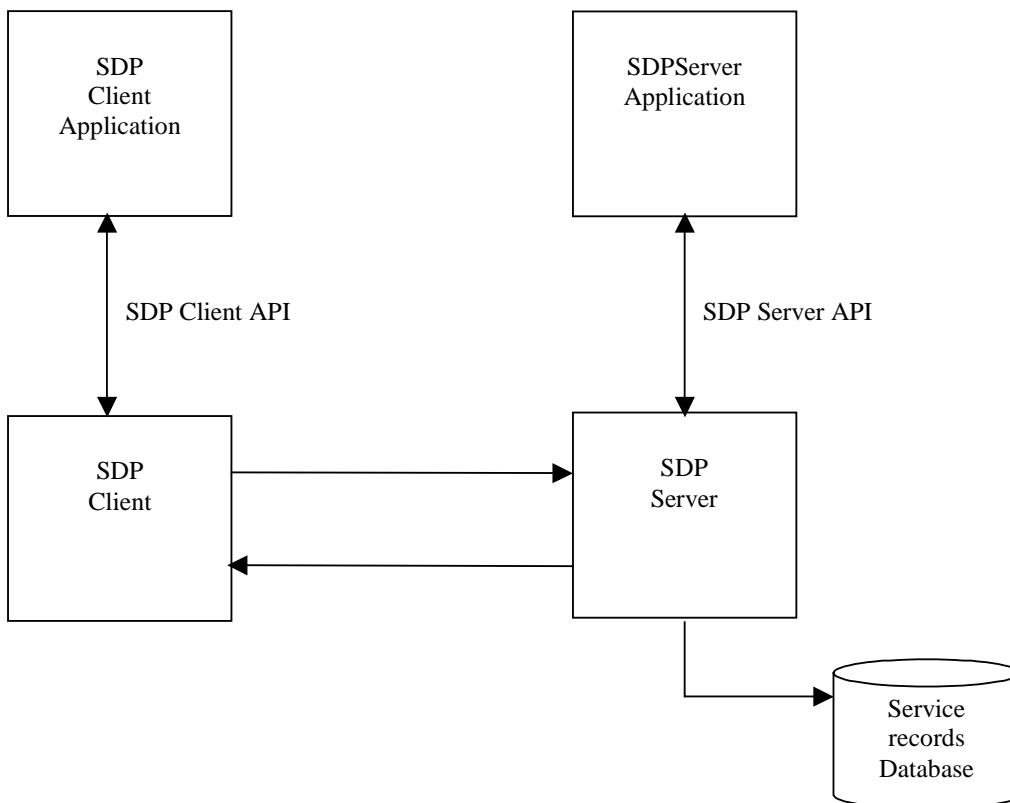

Figure L.1

The server maintains a Service Record Database that describe the characteristics of services associated with the server. Each service record contains information about a single service. A client may retrieve information from a service record maintained by the SDP Server by issuing an SDP request.

The notion of Service Record need to be presented here for a better understanding of function set introduced. We have seen that the SDP server must maintain a list of record describing services present on the device.

The service record consists entirely of a list of service attributes.

A service record handle is a 32-bit number that uniquely identifies each service record within an SDP server.

L.1 Service attribute

Each service attribute describes a single characteristic of a service. Each service attribute consists of two components: an attribute ID and an attribute value. The set of attributes characterizing one service are gathered in a service record. Table L.1 introduces examples of attributes that can be used in a service record.

Table L.1

ServiceClassIdList	Identifies the type of service represented by a service record. In other words, the list of classes of which the service is an instance
ServiceID	Uniquely identifies a specific instance of a service
ProtocolDescriptorList	Specifies the protocol stack(s) that may be used to utilize a service
ProviderName	The textual name of the individual or organization that provides a service
ServiceName	A text string containing a human readable name for the service
ServiceDescription	A text string describing the service

The USAT application shall provide such record to the SDP server in order to become reachable by any other device. Information shall be presented to the SDP server in the good format (see Bluetooth specification [16]) to be easily integrated in its own Service record Database.

Following is a brief description of the way by which a USAT application could retrieve a service residing on another device.

A Bluetooth device can perform a search by Patterns (Service UUID or Attributes) or by browsing. A service browsing must interact with the user. We here prefer that the USAT application simply sends a search that the SDP Client terminal software will perform. The USAT application will perform a Service Search with a service search pattern. A service search pattern is a list of UUIDs used to locate matching service records. The USAT application will prepare PDU(s) that the SDP client software will just have to push to L2CAP layer and to SDP Server software residing on another device. Once the USAT gets the list of services available, it can get further information on the services and then select one to perform an OPEN CHANNEL.

Annex M (informative): Use of CAT bearer independent protocol for local links, server case

This annex applies to classes "e" and "f".

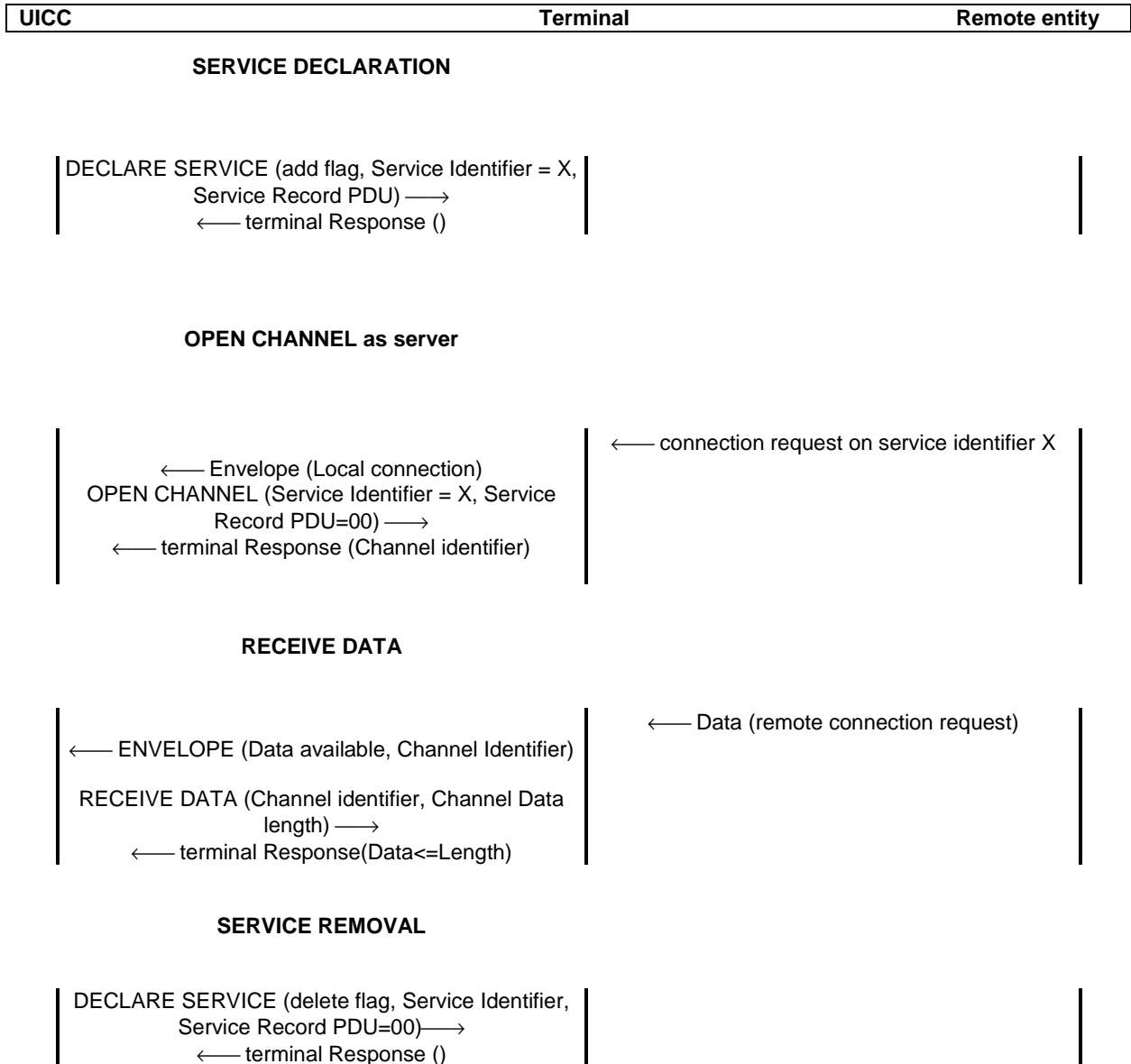

Figure M.1

Annex N (informative): Bibliography

- ETSI TS 100 906: "Digital cellular telecommunications system (Phase 2+) (GSM); Mobile Station (MS) features (GSM 100 906)".
- ETSI TS 100 812: "Terrestrial Trunked Radio (TETRA); Security aspects; Subscriber Identity Module to Mobile Equipment (SIM - ME) interface".
- ITU-T Recommendation E.163: "Numbering plan for the international telephone service".

Annex O (informative): Change history

The table below indicates changes that have been incorporated into the present document since it was created by EP SCP.

Change history								
Date	Meeting	EP SCP Doc.	CR	Rv	Cat	Subject/Comment	Old	New
2000-11	SCP-03	9-00-0428	-			Initial draft based on 3GPP TS 31.111 V4.0.0 with modifications introduced by rapporteur		0.0.0
2000-12	SCP-04	SCP-010031	-			Outcome of EP SCP ad hoc meeting on CAT in December 2000. Submitted to EP SCP #4 for information and discussion	0.0.0	0.1.0
2001-02	-	SCP-010101	-			Outcome of EP SCP ad hoc meeting on CAT in February 2001. Alignment with 3GPP TS 31.111 V4.1.0	0.1.0	0.2.0
2001-03	SCP-05	SCP-010105	-			Result of drafting session during EP SCP #5	0.2.0	0.3.0
2001-03	SCP-05	SCP-010147	-			Editorial and formatting enhancements. Version number raised to 1.0.0 in line with decision at EP SCP #5	0.2.0	1.0.0
2001-06	SCP-06	SCP-010203	-			Outcome of EP SCP #6. Alignment with 3GPP TS 31.111 V4.3.0	1.0.0	1.1.0
2001-07	-	-	-			First editorial clean up following approval at EP SCP #6. This version has been sent to the ETSI secretariat for publication in July 2001 as TS 102 223 V4.0.0. No technical changes compared to V1.1.0	1.1.0	1.1.1
2001-07	-	-	-			ETSI Publication - no technical changes compared to V1.1.1	1.1.1	4.0.0
2001-10	SCP-07	SCP-010260	001		B	Terminal Profile Harmonization with ANSI/TIA/EIA-136	4.0.0	4.1.0
		SCP-010279	002		F	Corrections to the OPEN CHANNEL command		
		SCP-010280	003		F	Corrections to SEND DATA commands and Channel Status Event		
		SCP-010304	004		F	Reservations for TIA/IS-820-A facilities		
2002-01	SCP-08	SCP-010386	005		F	Corrections related to the Bearer Independent Protocol	4.1.0	4.2.0
		SCP-010384	006		F	Addition of a generic SEND SM command		
2002-06	SCP-10	SCP-020171	007	1	F	Correction of Terminal Response references	4.2.0	4.3.0
		SCP-020110	008		F	Correction of byte 17 in Terminal Profile		
		SCP-020111	009		F	Usage of Simple TLV Tag Values		
		SCP-020112	010		F	Reservation of tags&values for 3GPP2		
		SCP-020115	013		F	Correction to OPEN CHANNEL for packet data service		
2003-01	SCP-12	SCP-020114	012		F	Correction of ENVELOPE(Call Control) structure description	4.3.0	4.4.0
		SCP-030069	016	1	F	Set of corrections		
		SCP-030071	017	1	F	Corrections and editorial modifications		
		SCP-030032	014		F	Clarification of the usage of busy status response for Event download and Menu Selection Envelope.		
2003-05	SCP-13	SCP-030117	022		F	Collection of alignments with 3GPP	4.4.0	4.5.0
2003-09	SCP-14	SCP-030211	030		F	Correction of the definition of the UICC	4.5.0	4.6.0
			025		F	Correction of Item Icon Identifier list coding example		

History

Document history		
V4.0.0	July 2001	Publication
V4.1.0	October 2001	Publication
V4.2.0	March 2002	Publication
V4.3.0	July 2002	Publication
V4.4.0	February 2003	Publication
V4.5.0	June 2003	Publication
V4.6.0	September 2003	Publication